

The Cumulus Parameterization Problem in the Context of MJO Simulations

by

Jun-Ichi Yano

**ECMWF Collaboration with
Peter Bechtold, Adrian Tompkins**

&

Thanks to Anton Beljaars

Outline

Overview:

Cumulus Parameterization Problem

MJO Identification

(with Adrian Tompkins, Peter Bechtold)

Global Analysis (ECMWF Model)

**(with P. Bechtold, J.Y. Grandpeix,
I. Musat)**

Convective-Scale Analysis

(with J.P. Chaboureaud, F. Guichard)

Data Sets: TOGA-COARE Period
(1 Sept. 1992 – 28 Feb. 1993)

- **Observation: ERA40 Reanalysis**
(12 hourly-data averaged over a day)
(precipitation from 12-36 h forecasts)
- **ECMWF Model (3 ensemble runs):**
6 months: T95 (200km):
IFS cycle 26R3 with analyzed SST
(precipitation: from a single run)
- **CRM Experiments: Three 5-day periods:**
2D, ~100 km domain: T95 (200km):

Cumulus Parameterization Problem

CISK or WISHE

(moisture) ? (CAPE
 i.e., energetics)

Quasi-Equilibrium
(Quasi-Stationary Balance)
or

Self-Criticality

(1/f-Noise)

?

Tropical Convective Variability
Tropical Western Pacific Observations
(TOGA-COARE)
Frequency-Spectra of CAPE:

(Degree of Convective Instability)

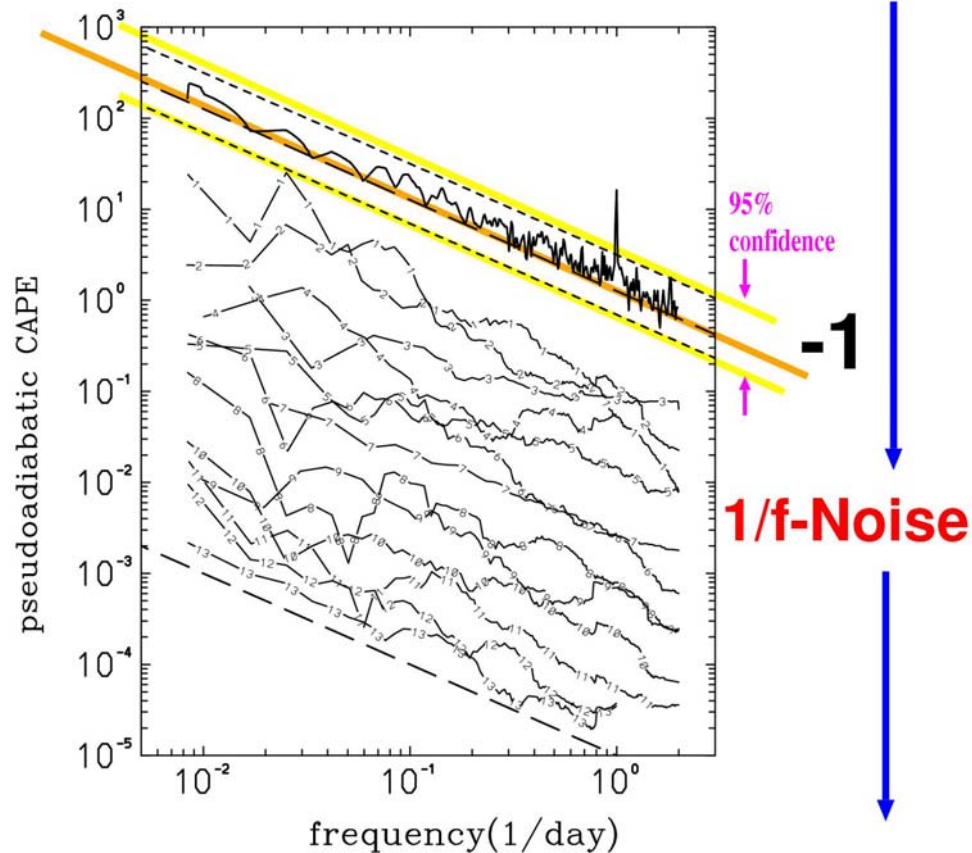

Self-Criticality ?

(Yano, Fraedrich, Blender 2001)

MJO in TOGA-COARE Period

Precipitation, 20S-20N

Global Analysis:

ERA40

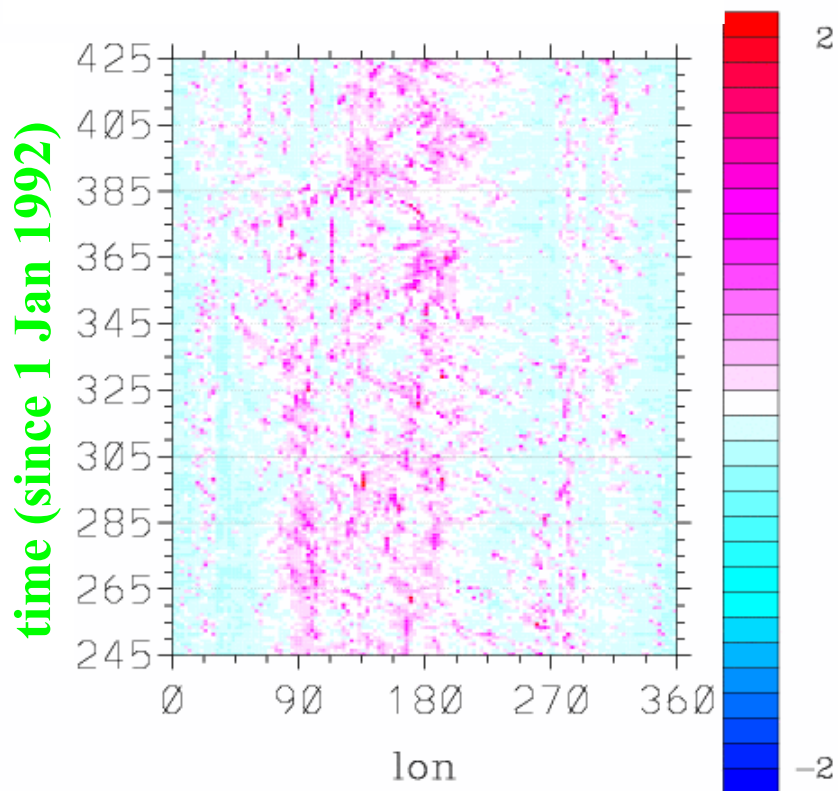

Model Forecast:

IFS 26R3

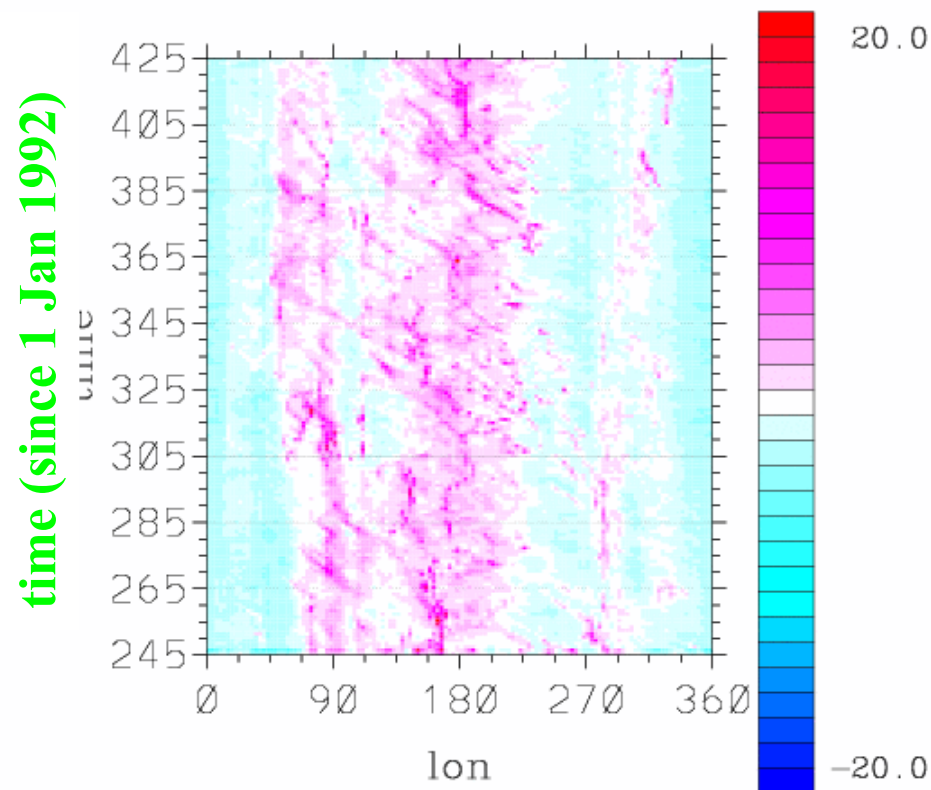

MJO in TOGA-COARE Period

Precipitation, 20S-20N

Global Analysis:
ERA40

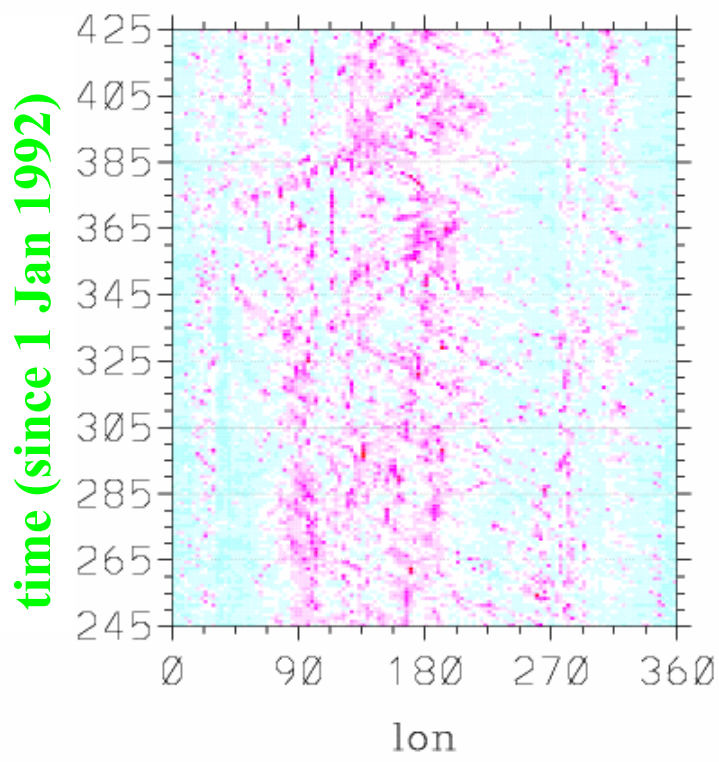

Global Analysis:
filtered by $k=4$

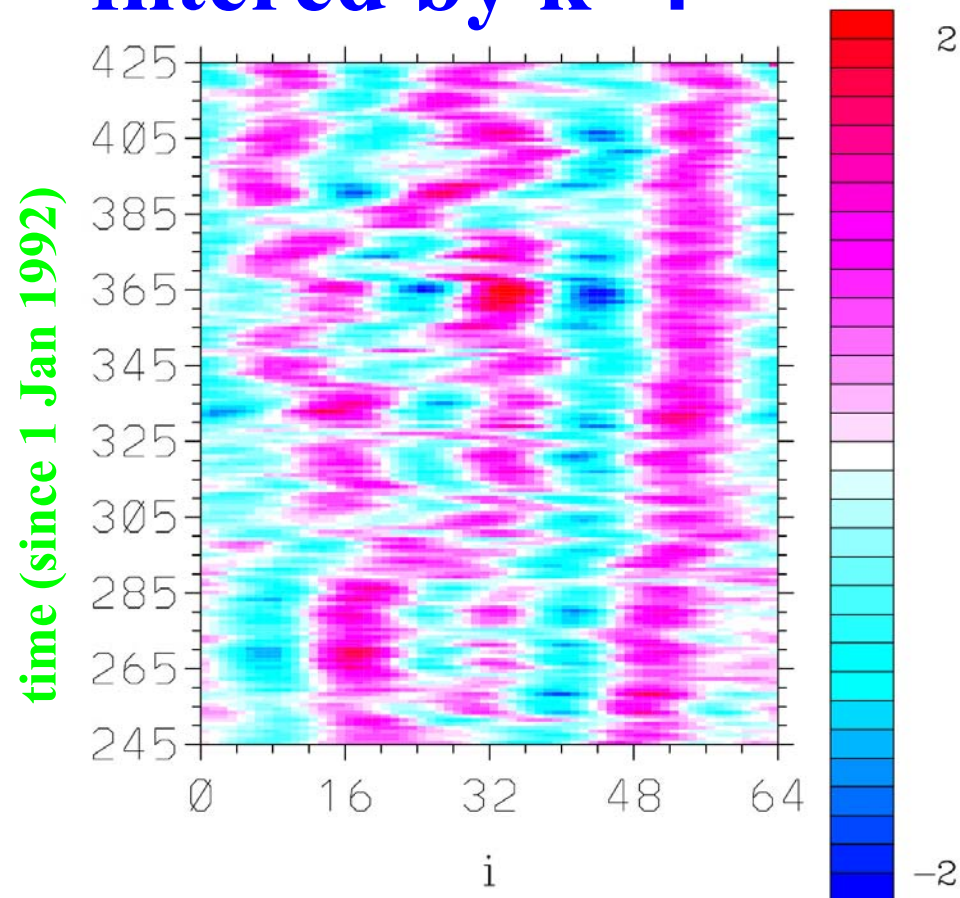

MJO in TOGA-COARE Period

Precipitation, 20S-20N

Global Analysis:
filtered by $k=4$

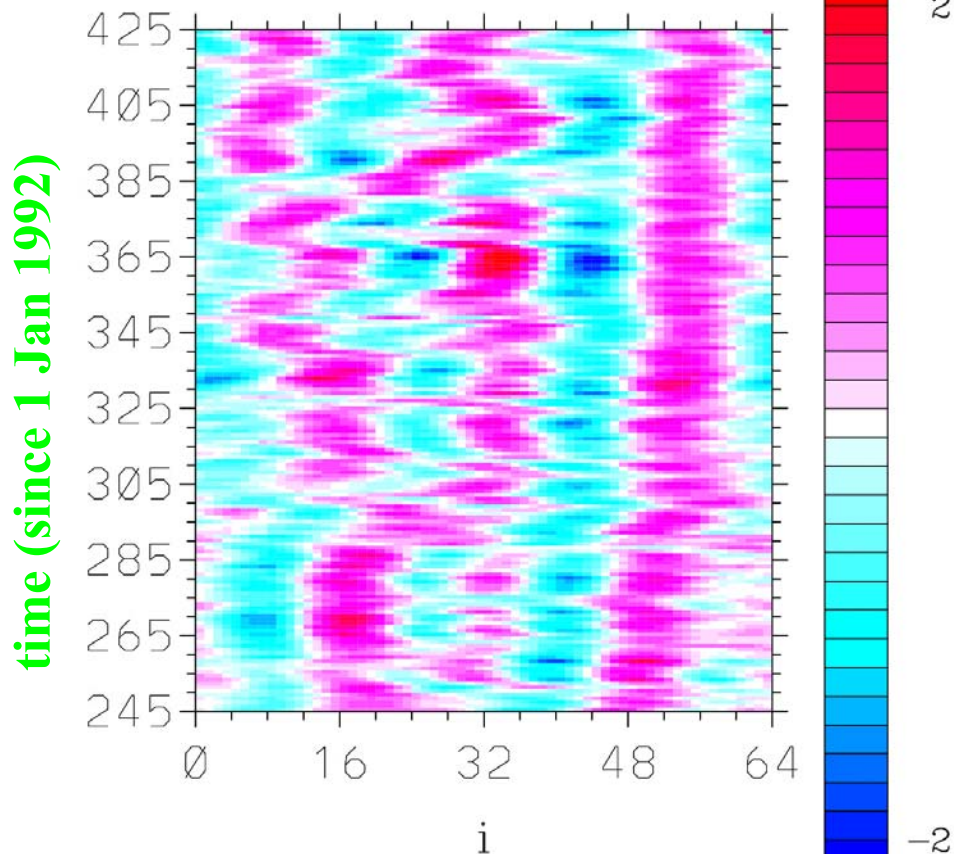

Global Forecast:
filtered by $k=4$

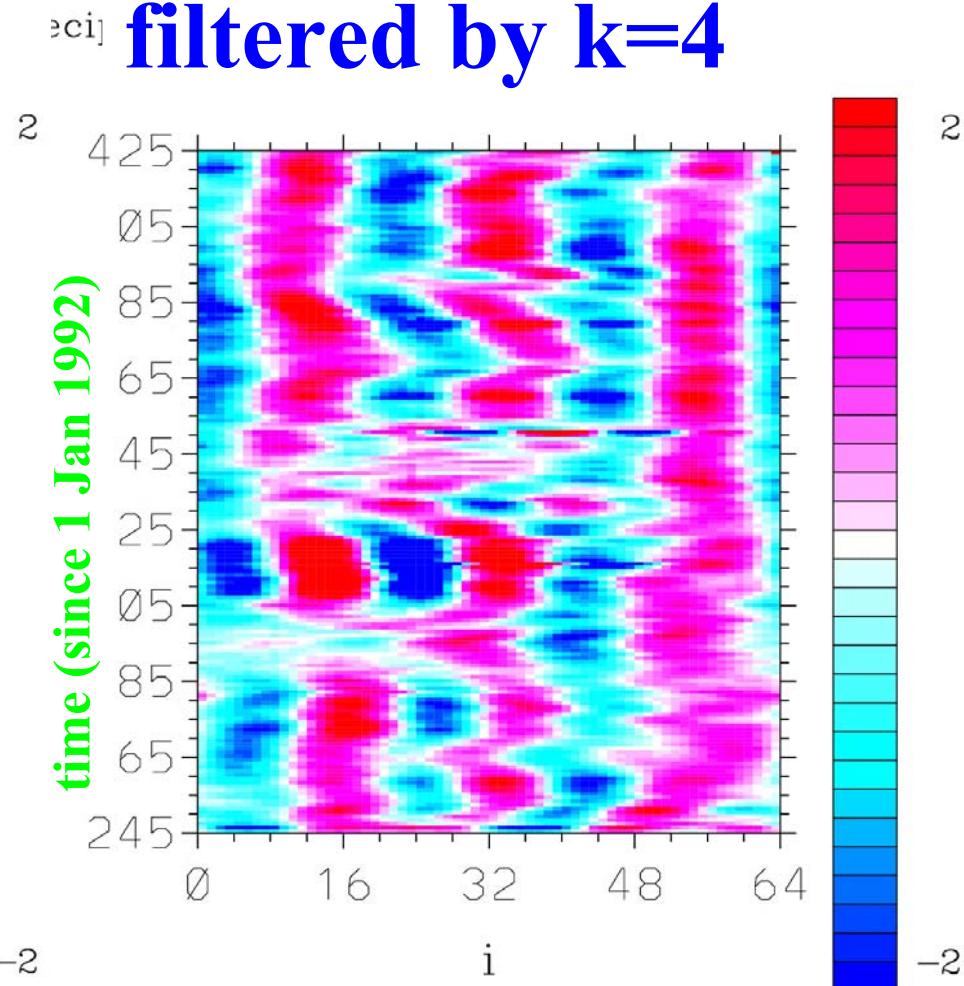

MJO in TOGA-COARE Period

Precipitation, 20S-20N

Global Analysis:

ERA40

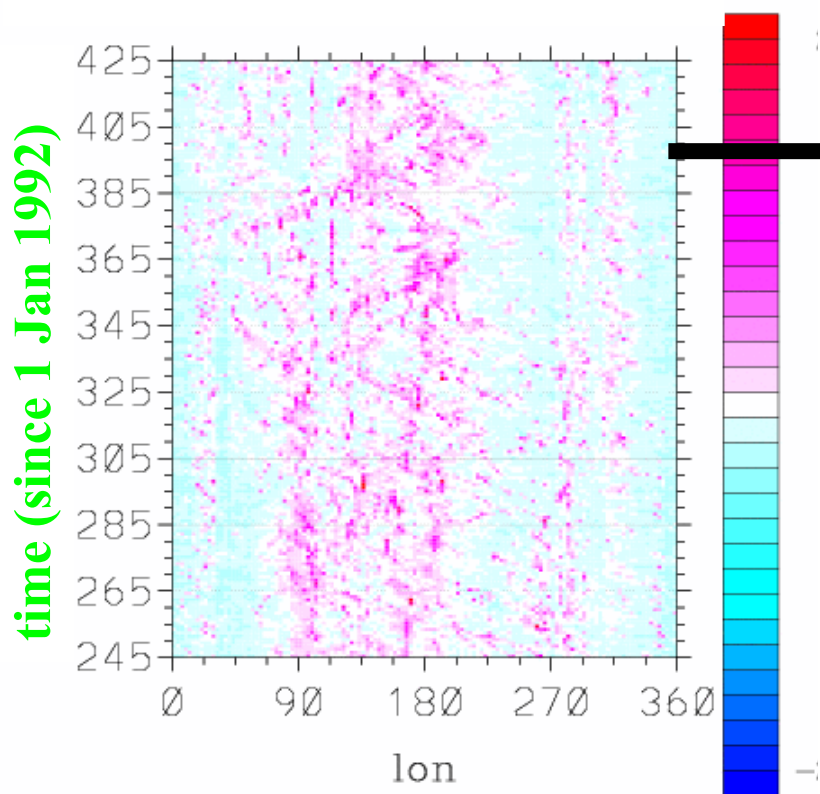

Precipitation (mm/day)

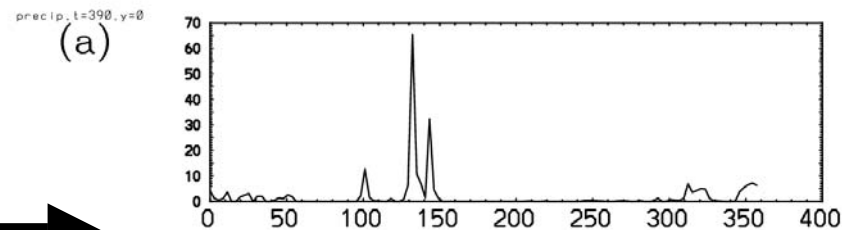

$t = 390, y = 0$

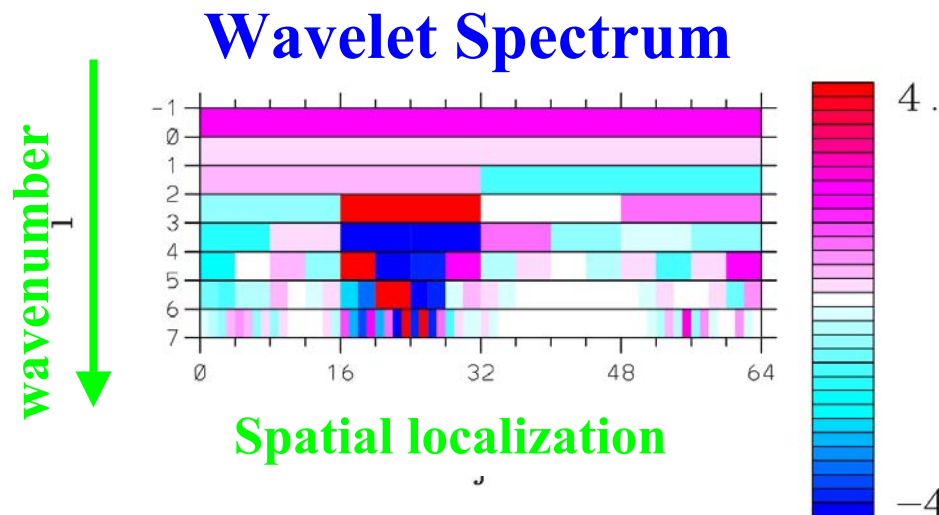

MJO in TOGA-COARE Period

Precipitation (mm/day), $t=390$, Equator

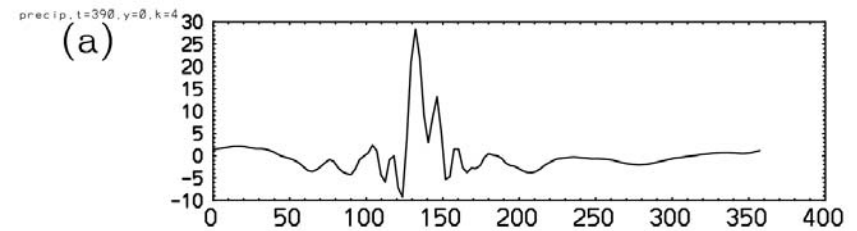
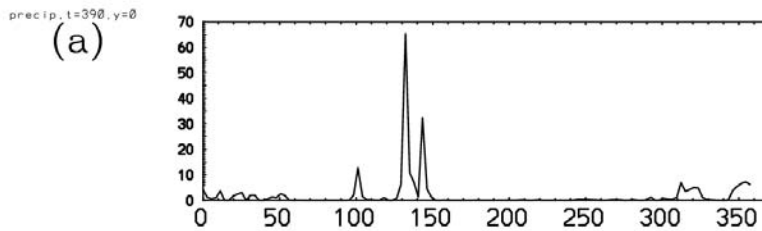

longitude

longitude

Total



k=4-pulse

Wavelet Spectrum

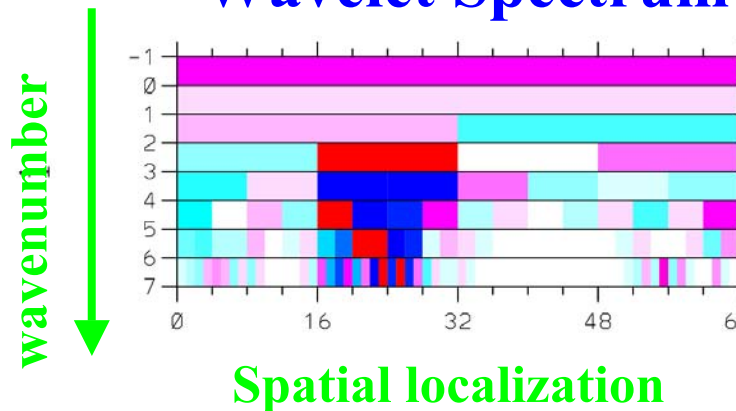

Wavelet Spectrum

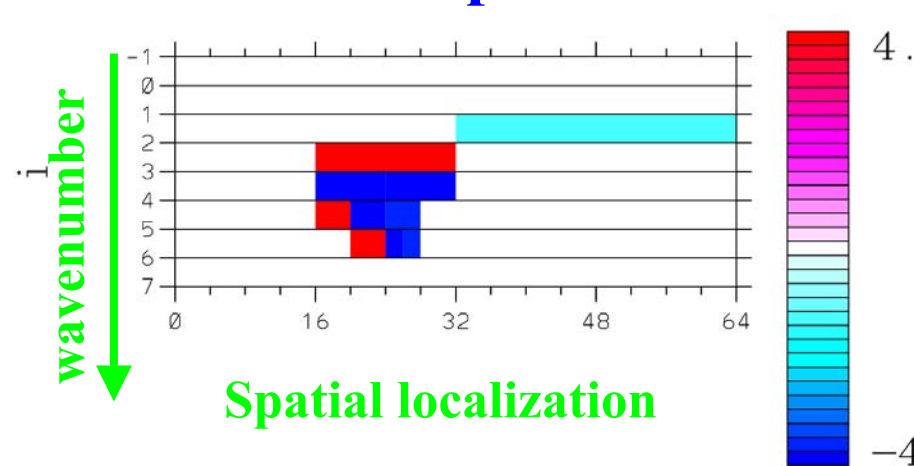

MJO in TOGA-COARE Period

Precipitation, 20S-20N

Global Analysis:

ERA40 (pulse k=2-8)

Precipitation (mm/day), t=390, y=0

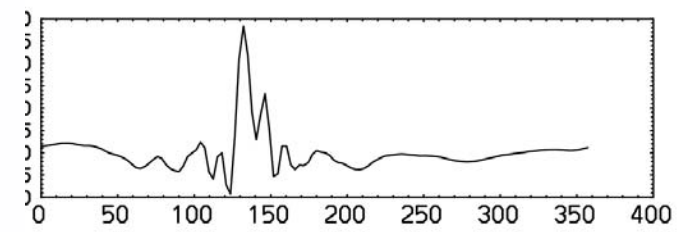

longitude

=4-pulse

Wavelet Spectrum

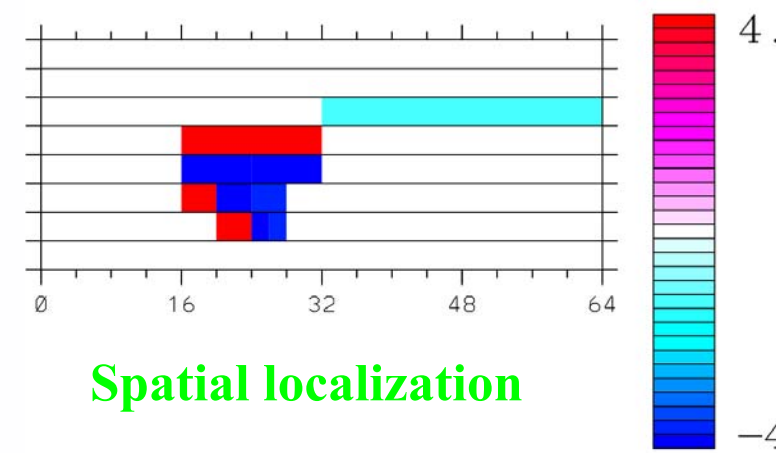

Spatial localization

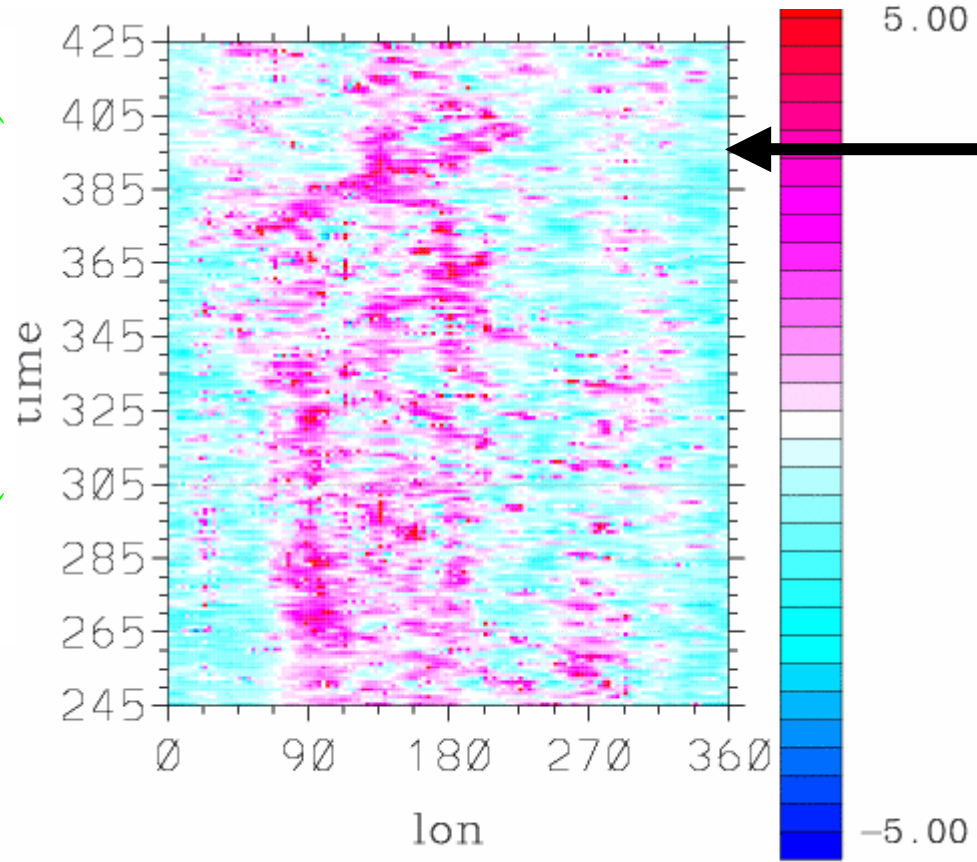

time (since 1 Jan 1992)

MJO in TOGA-COARE Period

Precipitation, 20S-20

Global Analysis:
ERA40 (pulse k=2-8)

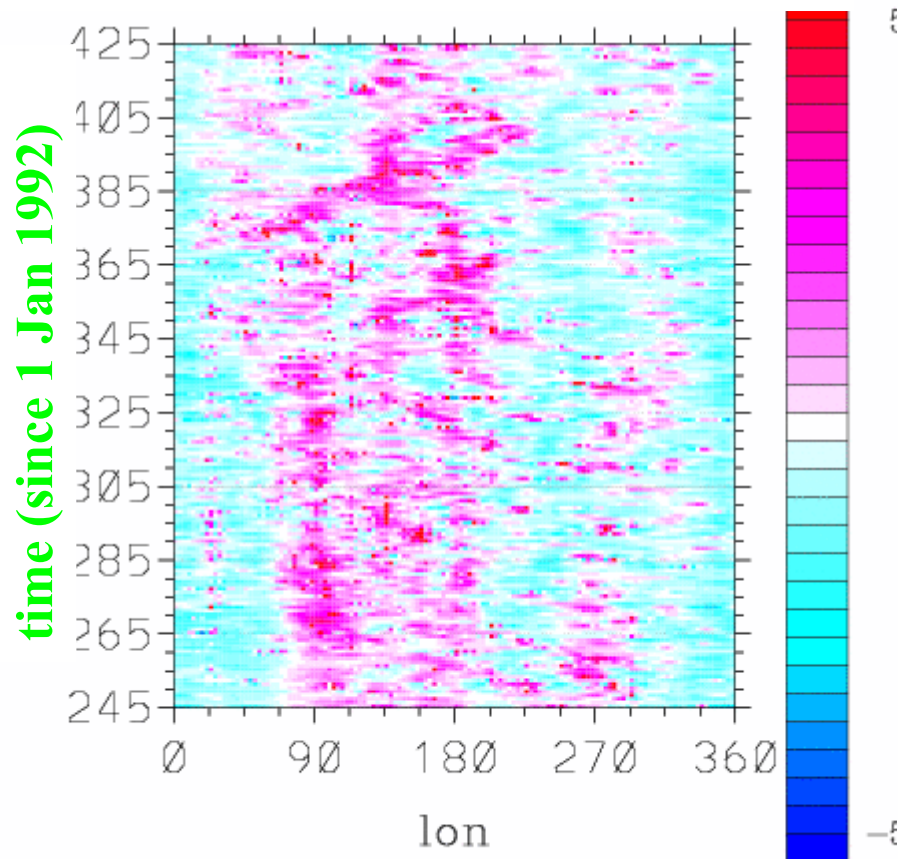

EC Model Forecast:
26R3 (pulse k=2-8)

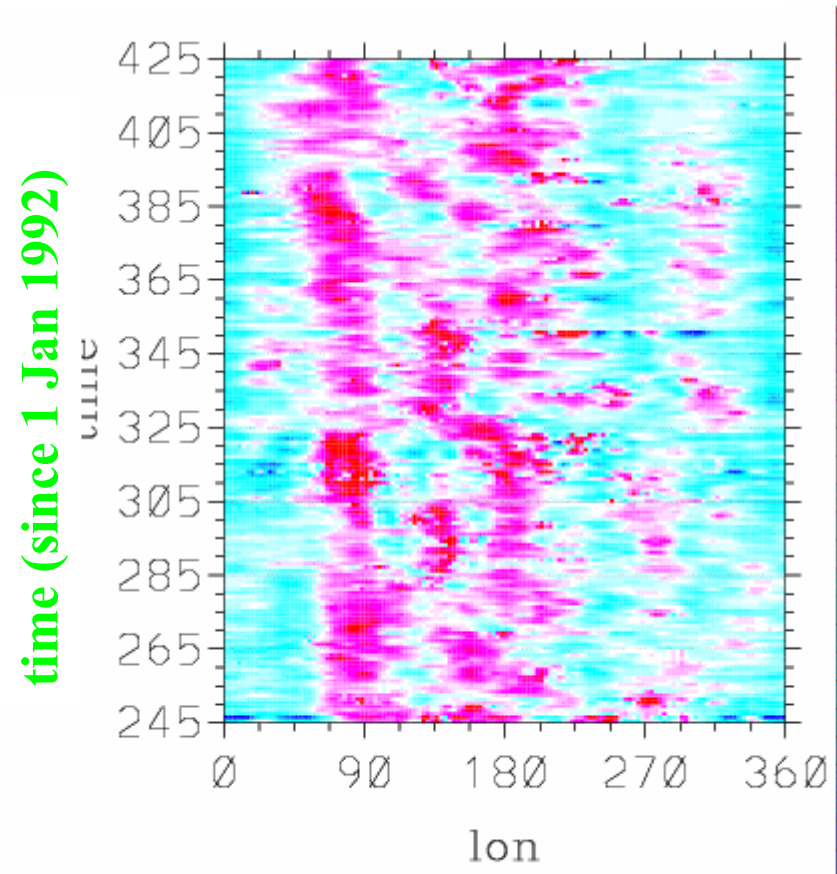

MJO in TOGA-COARE Period

Precipitation, 20S-20N: Correlation

Local

precipitation:pulse, total: local

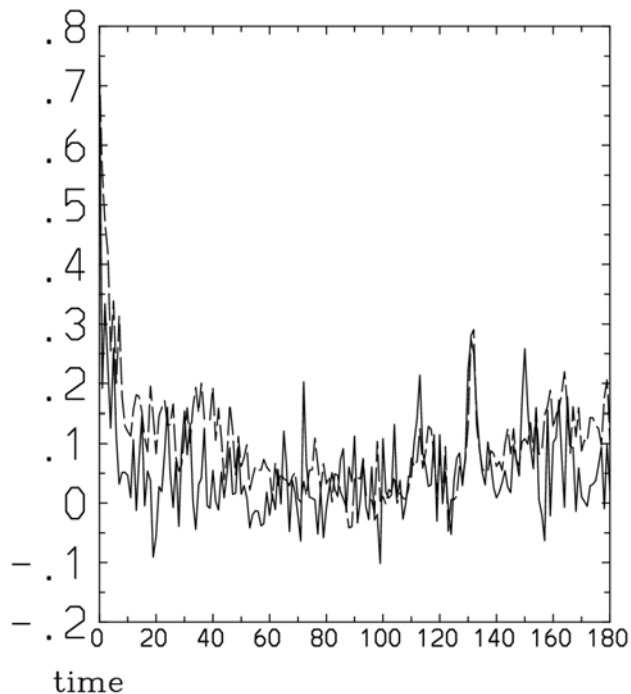

mean

precipitation:pulse, total: lat mean

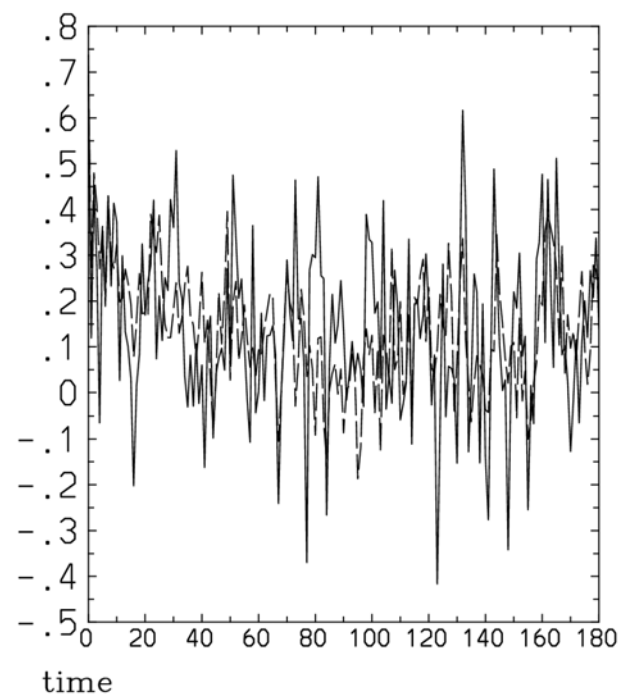

MJO in TOGA-COARE Period

Velocity Potential, 20S-20N

vp,pulse,k=1,4

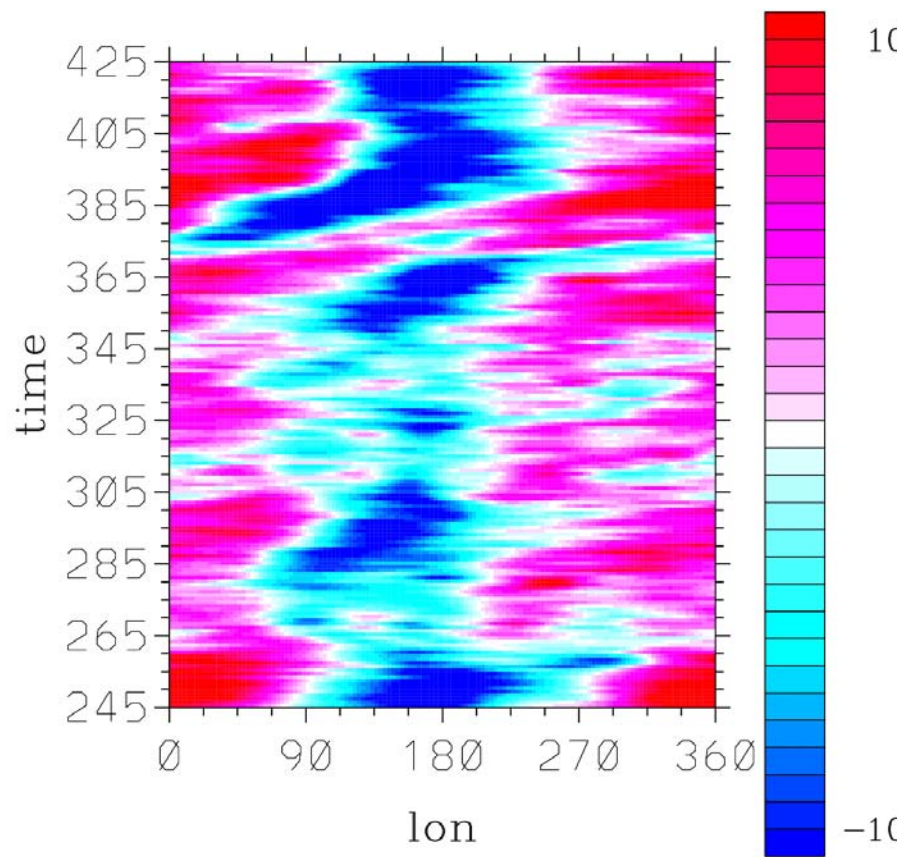

vp,26R3,k=1-4

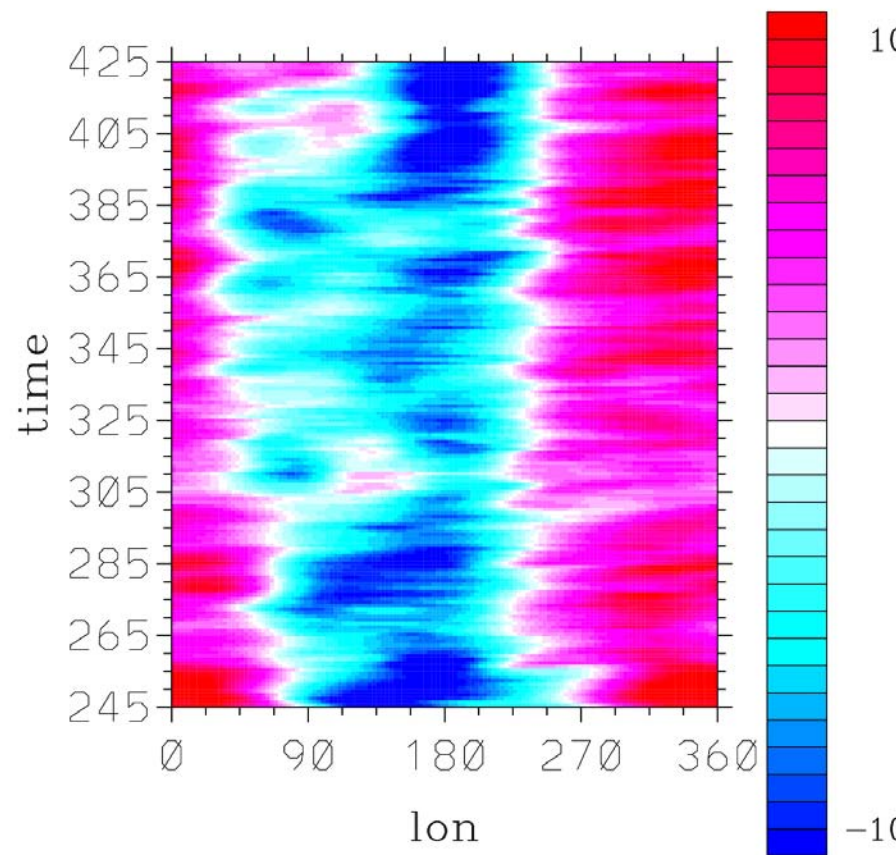

MJO in TOGA-COARE Period

Velocity Potential, 20S-20N: Correlation

Local

vp:pulse.totla-local

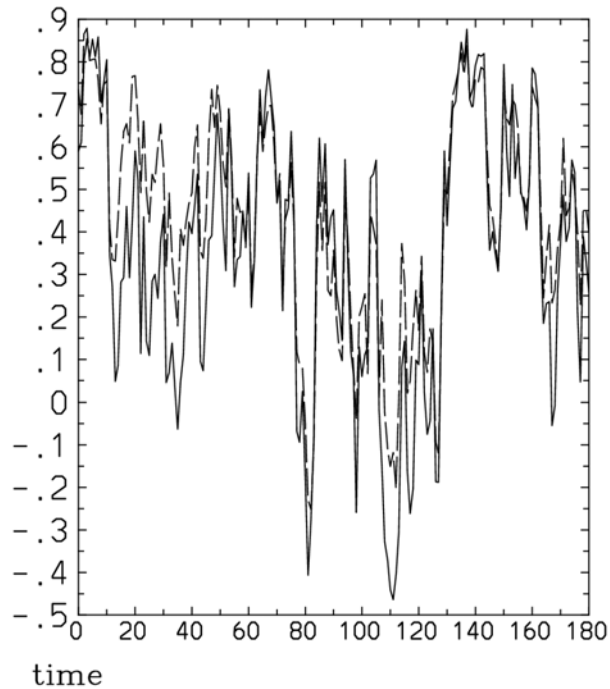

Latitudinal mean

vp:pulse.total-lat mean

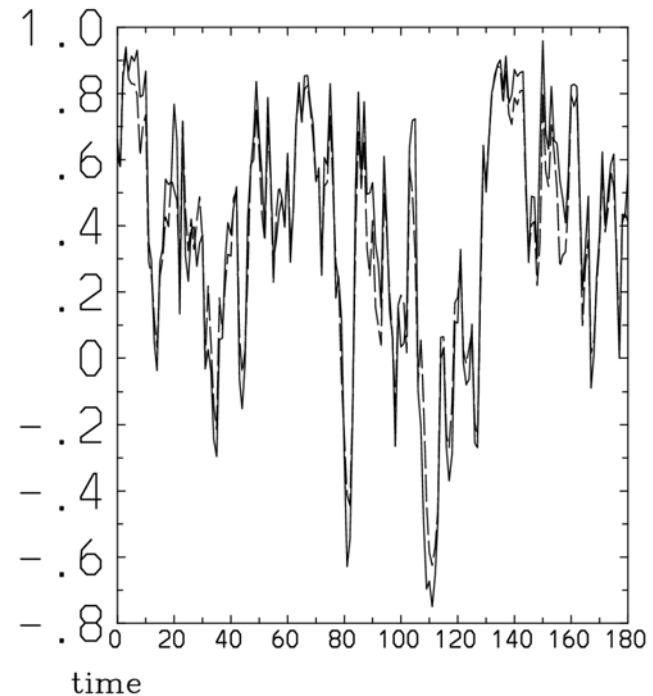

How MJO is maintained?:

Energy-Cycle Analysis

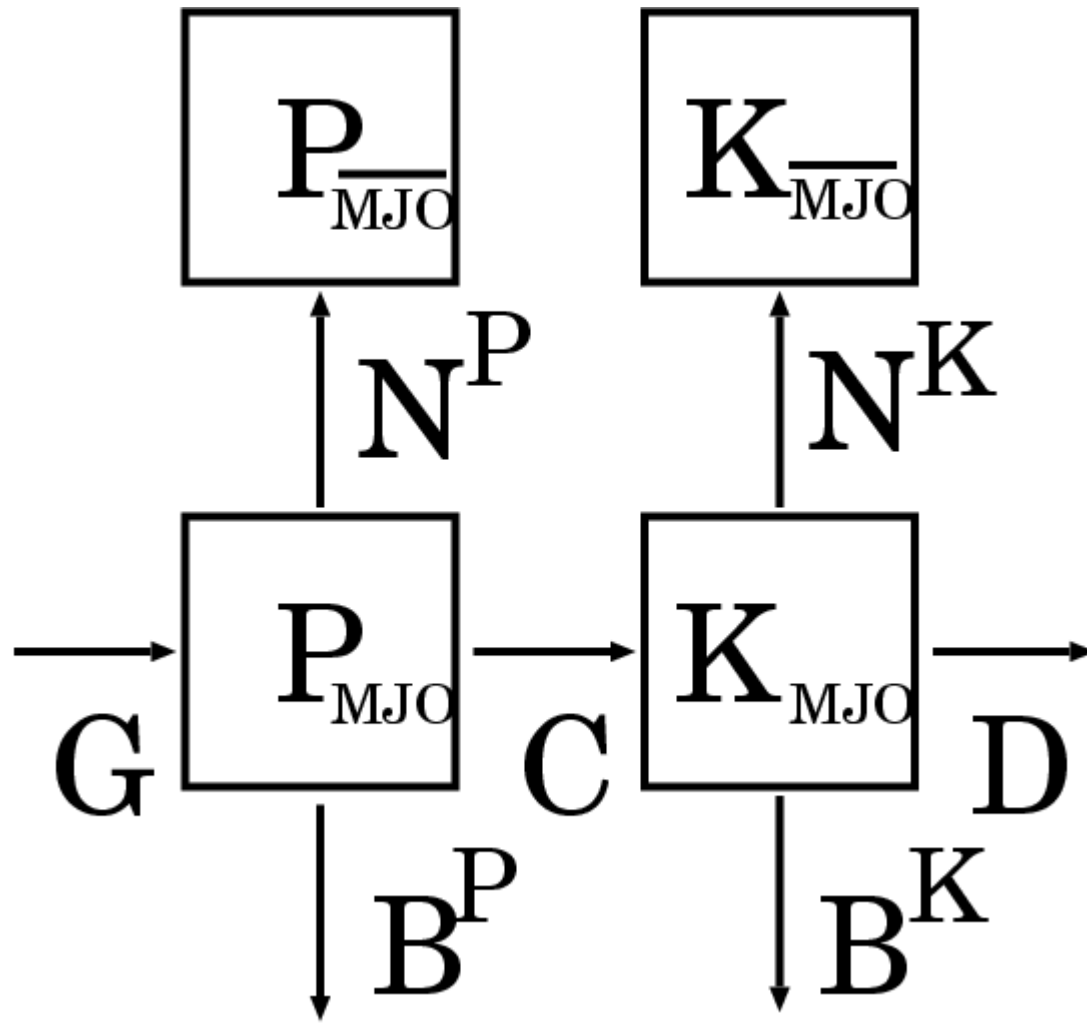

Discrete orthogonal Wavelets

(Meyer) : complete set

$k = 1$

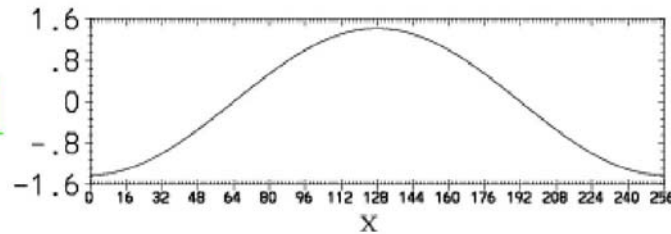

$k = 2$

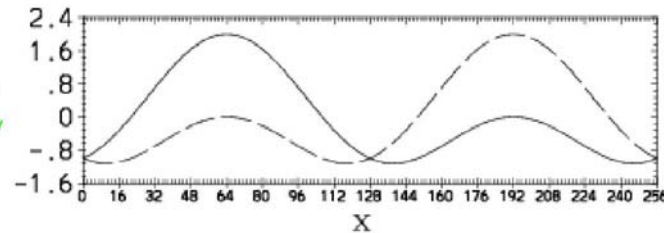

$k = 4$

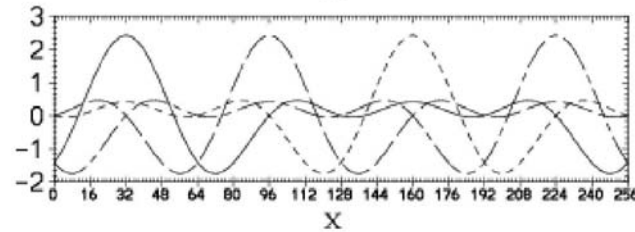

$k = 8$

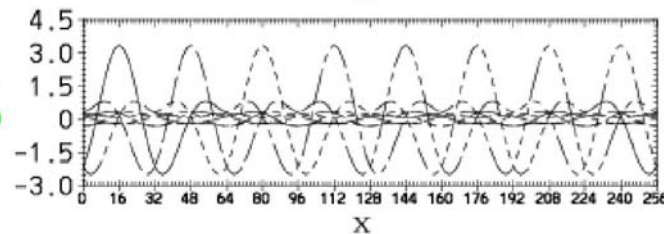

MJO in TOGA-COARE Period

ECMWF Model Forecast:

Precipitation, 20S-20N

real space

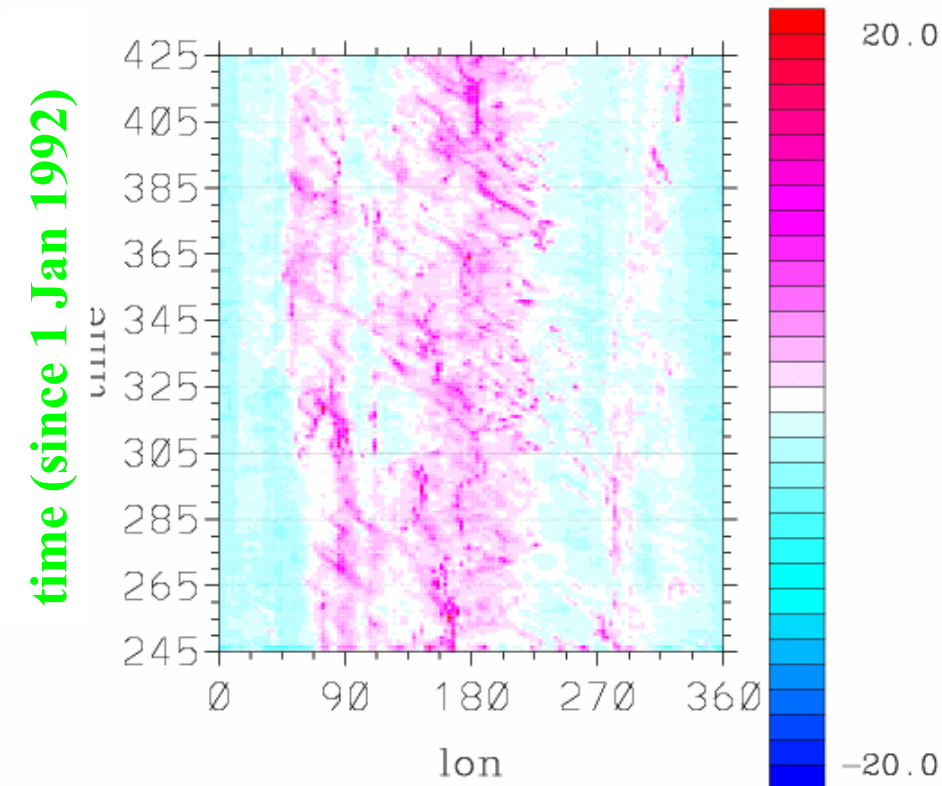

wavelet spectrum
($k = 4$)

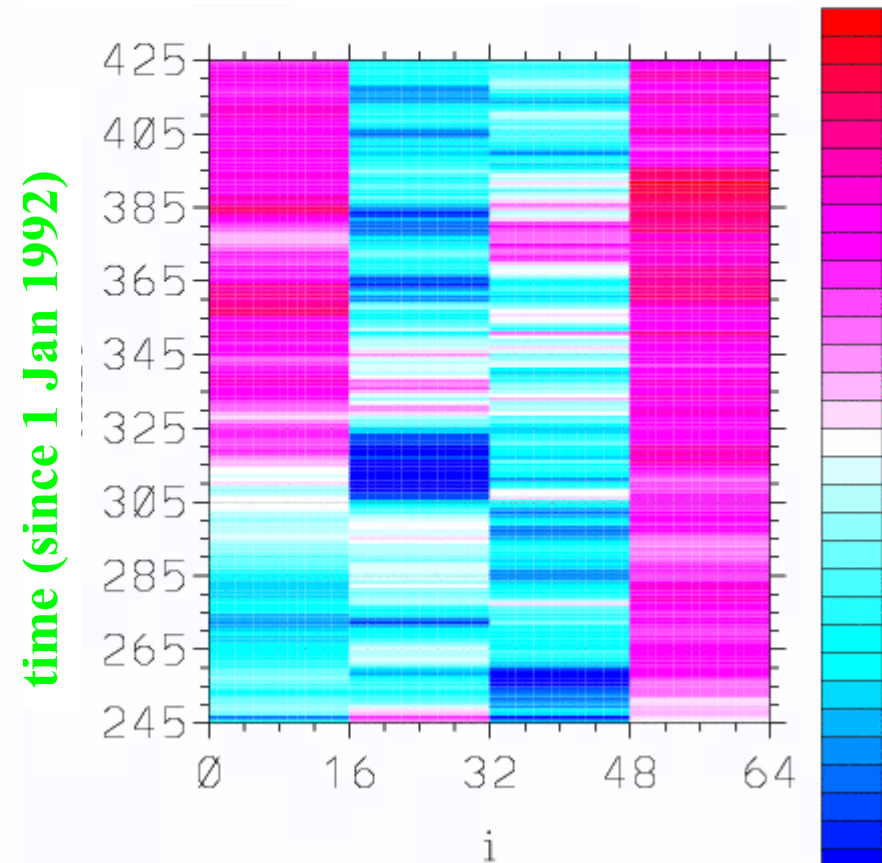

MJO in TOGA-COARE Period

ECMWF Model Forecast:

Precipitation, 20S-20N

cp = 0 m/s

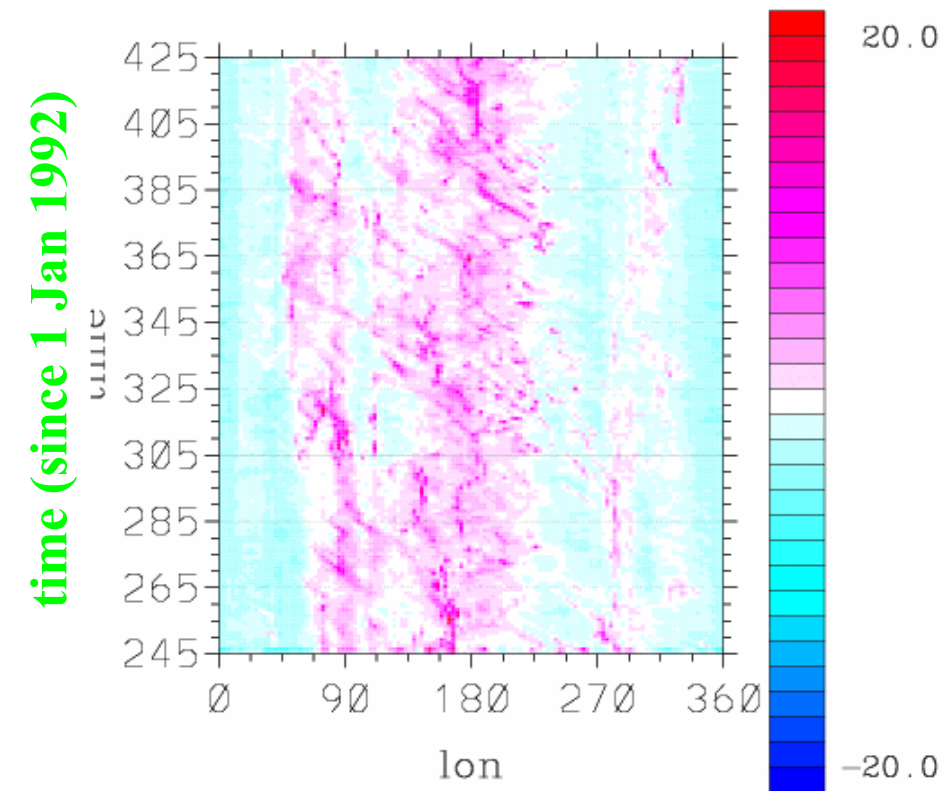

cp = 7 m/s

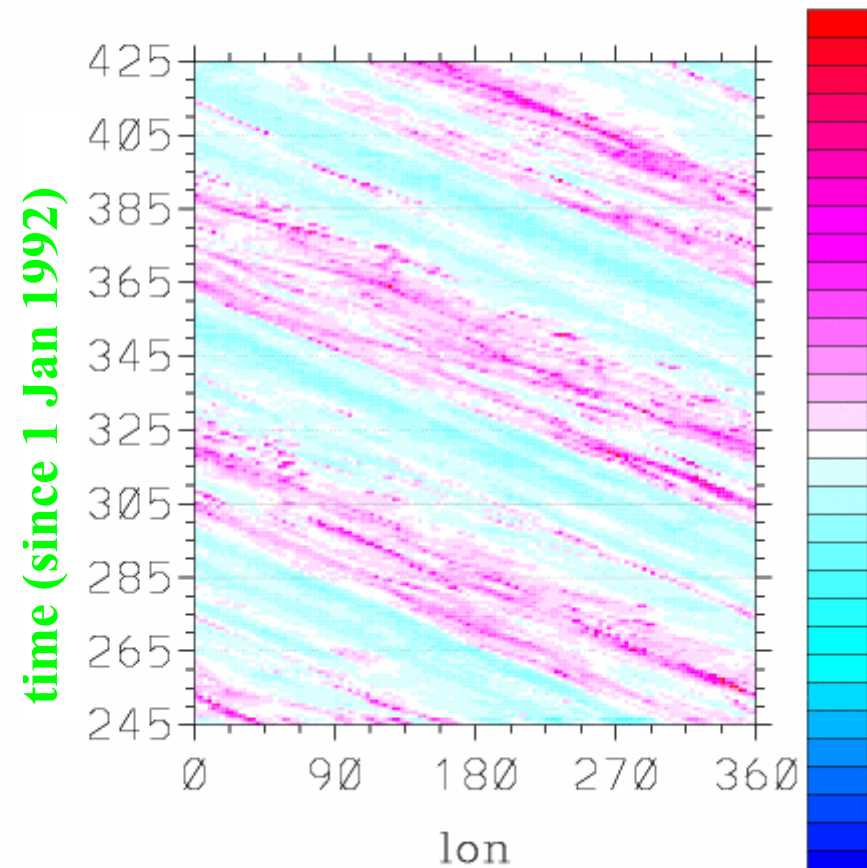

MJO in TOGA-COARE Period

ECMWF Model Forecast:

Precipitation, 20S-20N

Wavelet spectrum

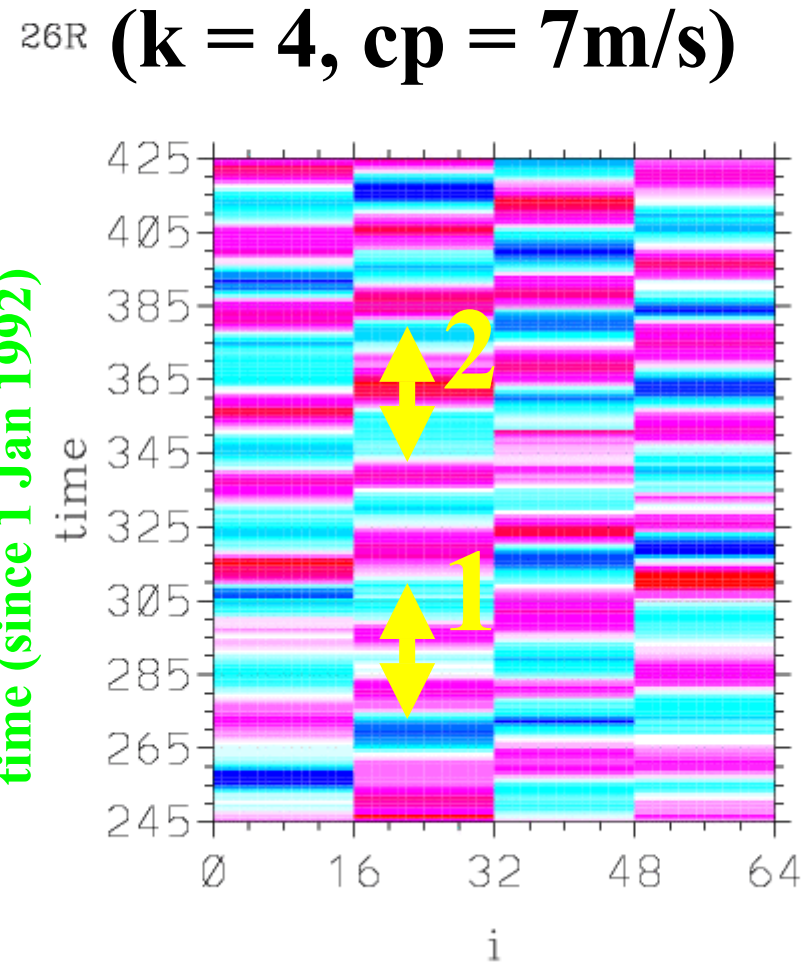
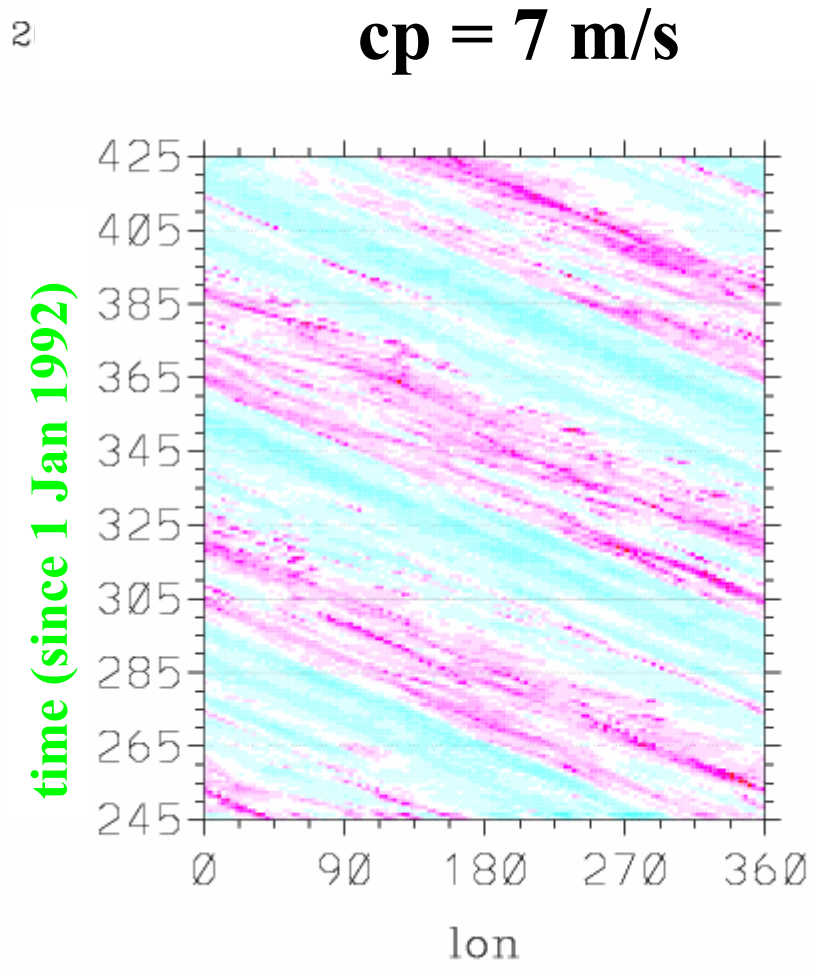

Energy Cycle with ECMWF Model

1st MJO event

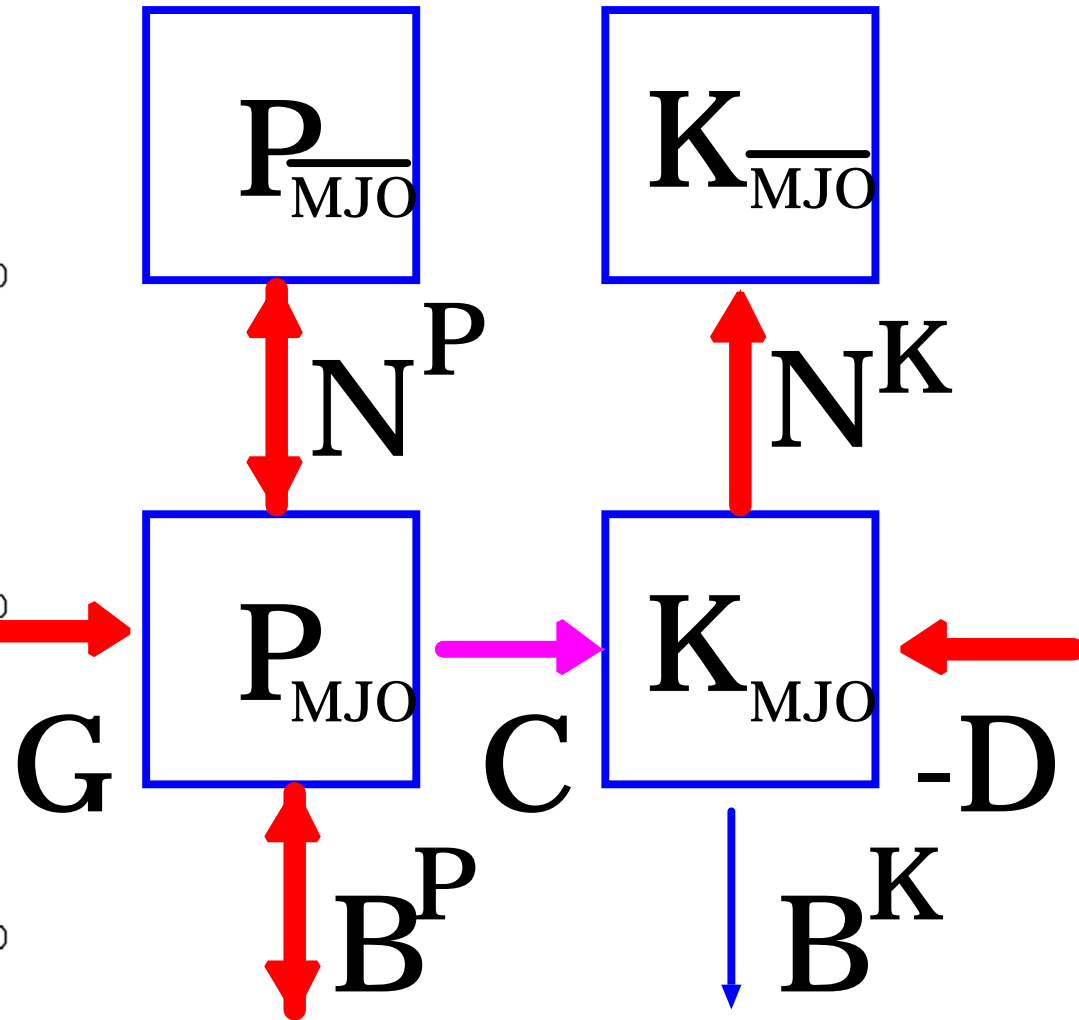
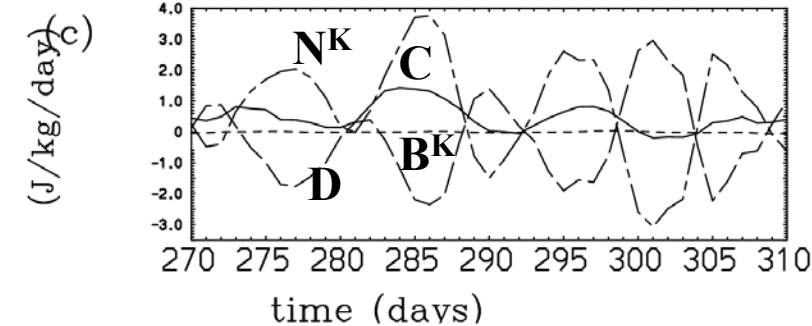
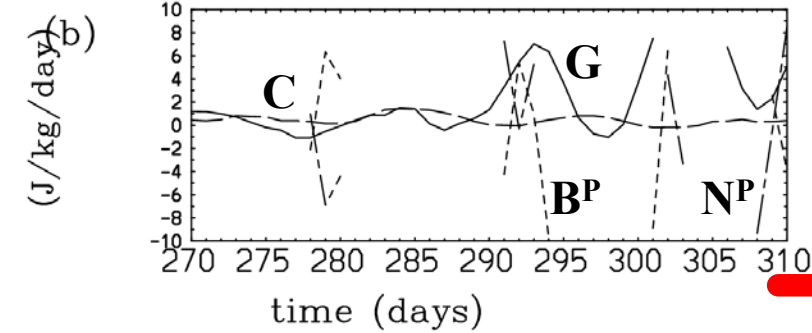
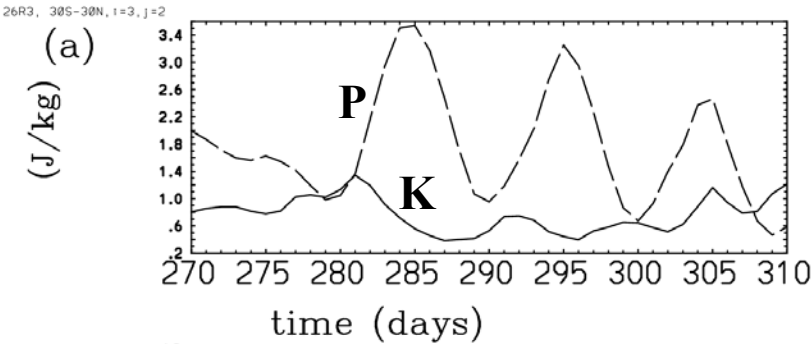

Energy Cycle

ECMWF Model

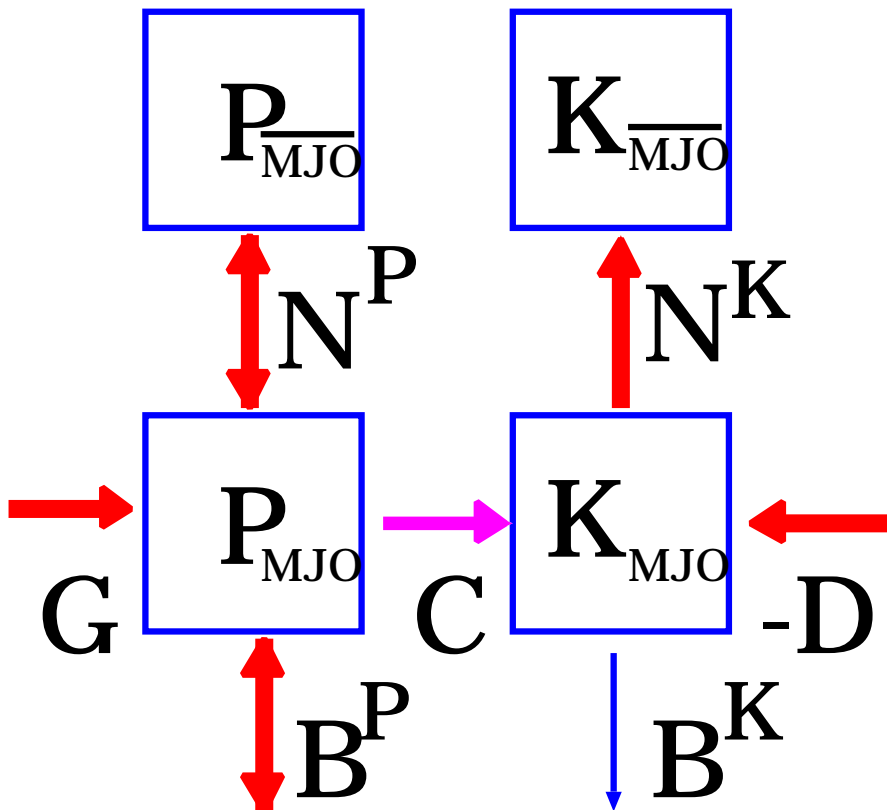

Standard Theory

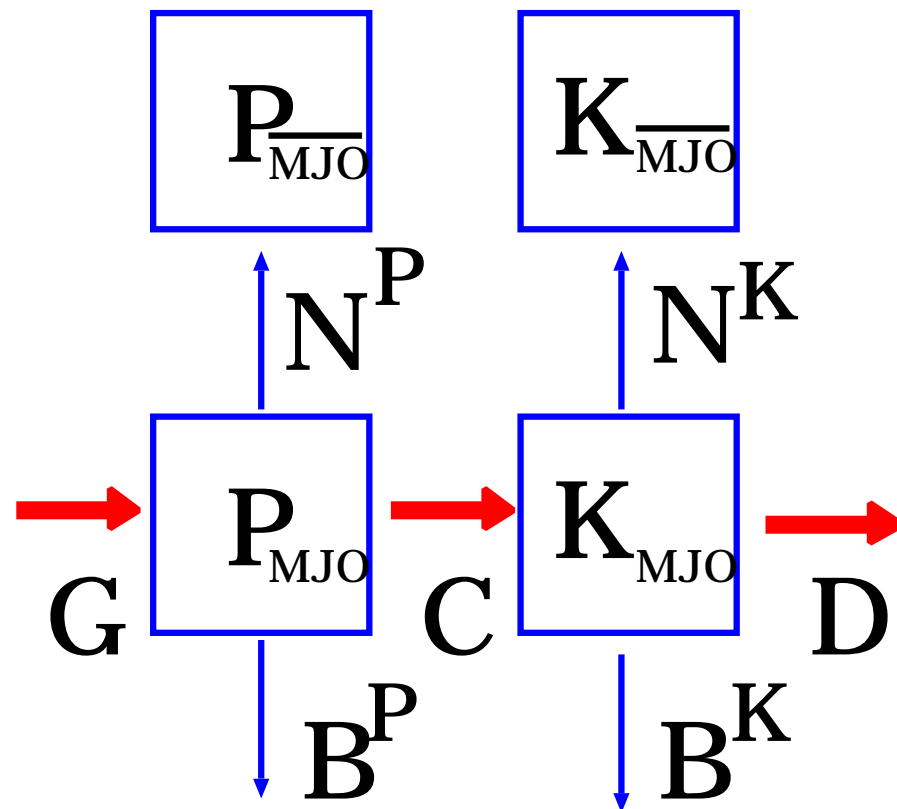

LMDZ Model Case

$C_p = 1.5 \text{ m/s}$

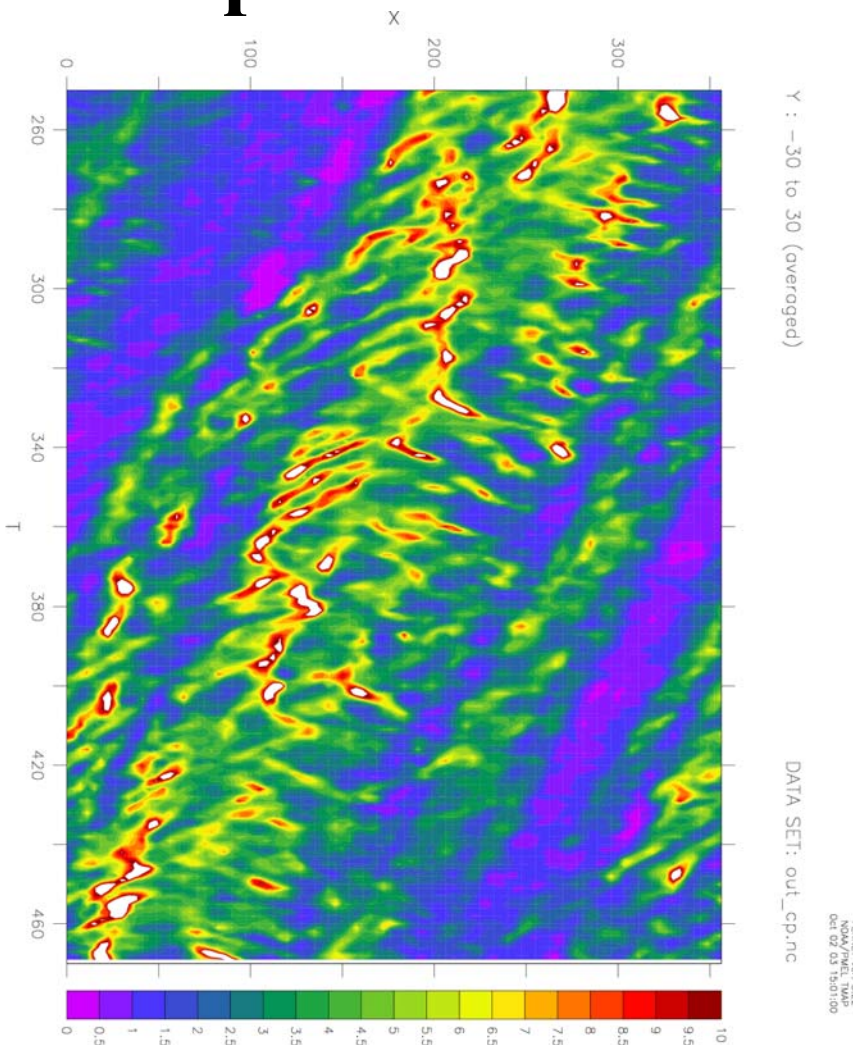
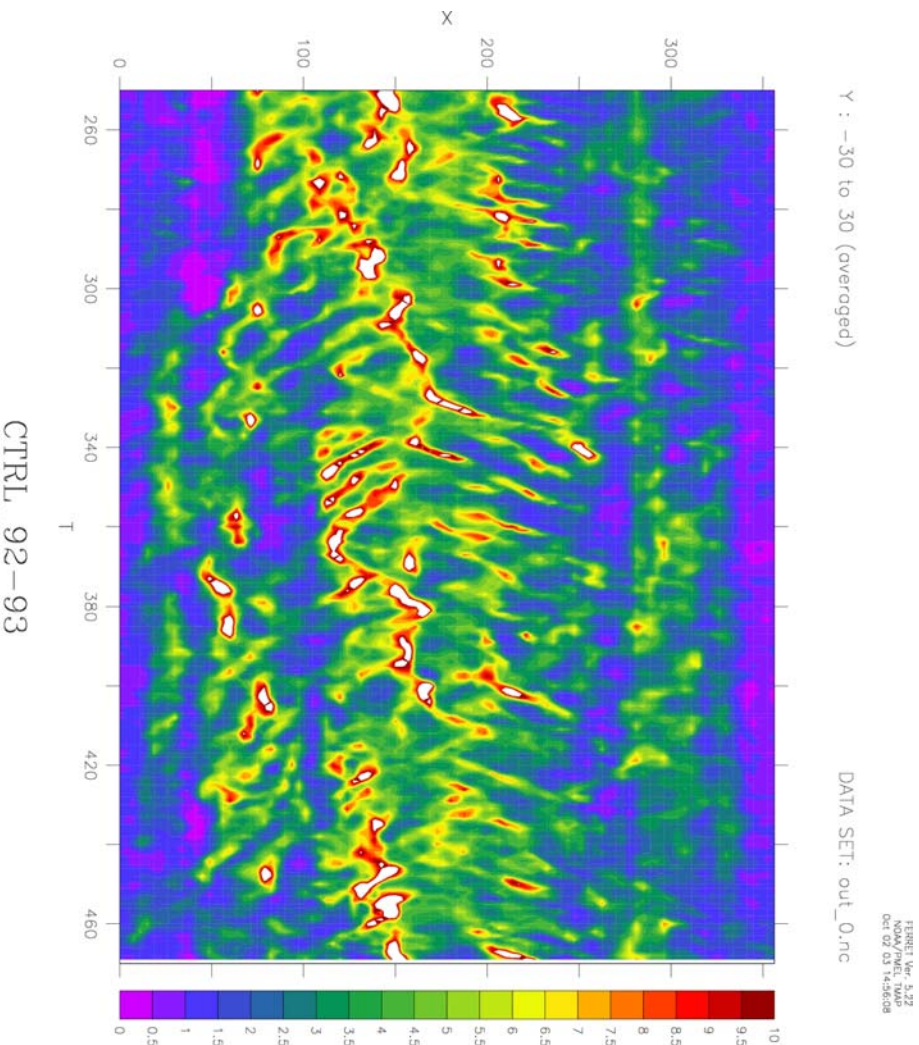

Energy Cycle with LMDZ Model

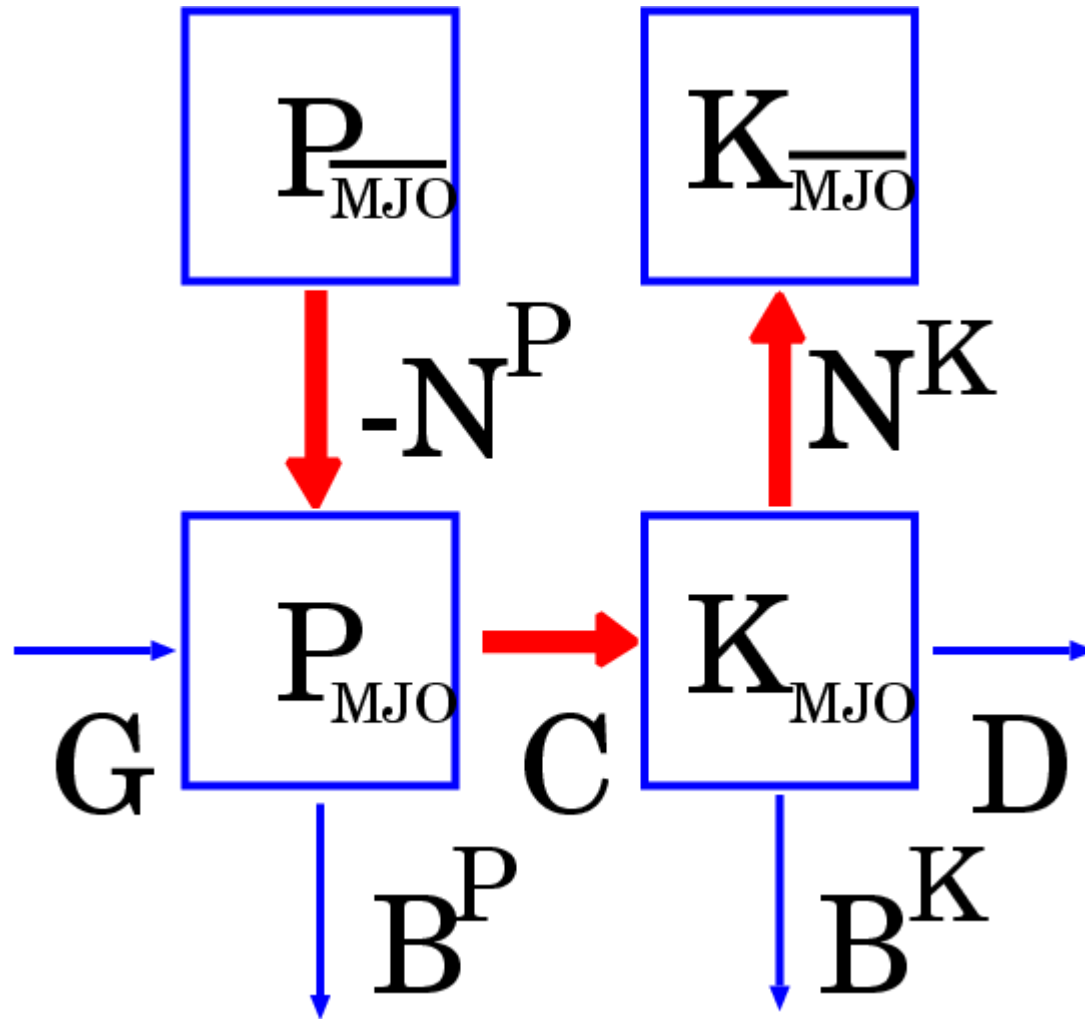

CRM Experiments (Redelsperger & Sommeria, 2D)

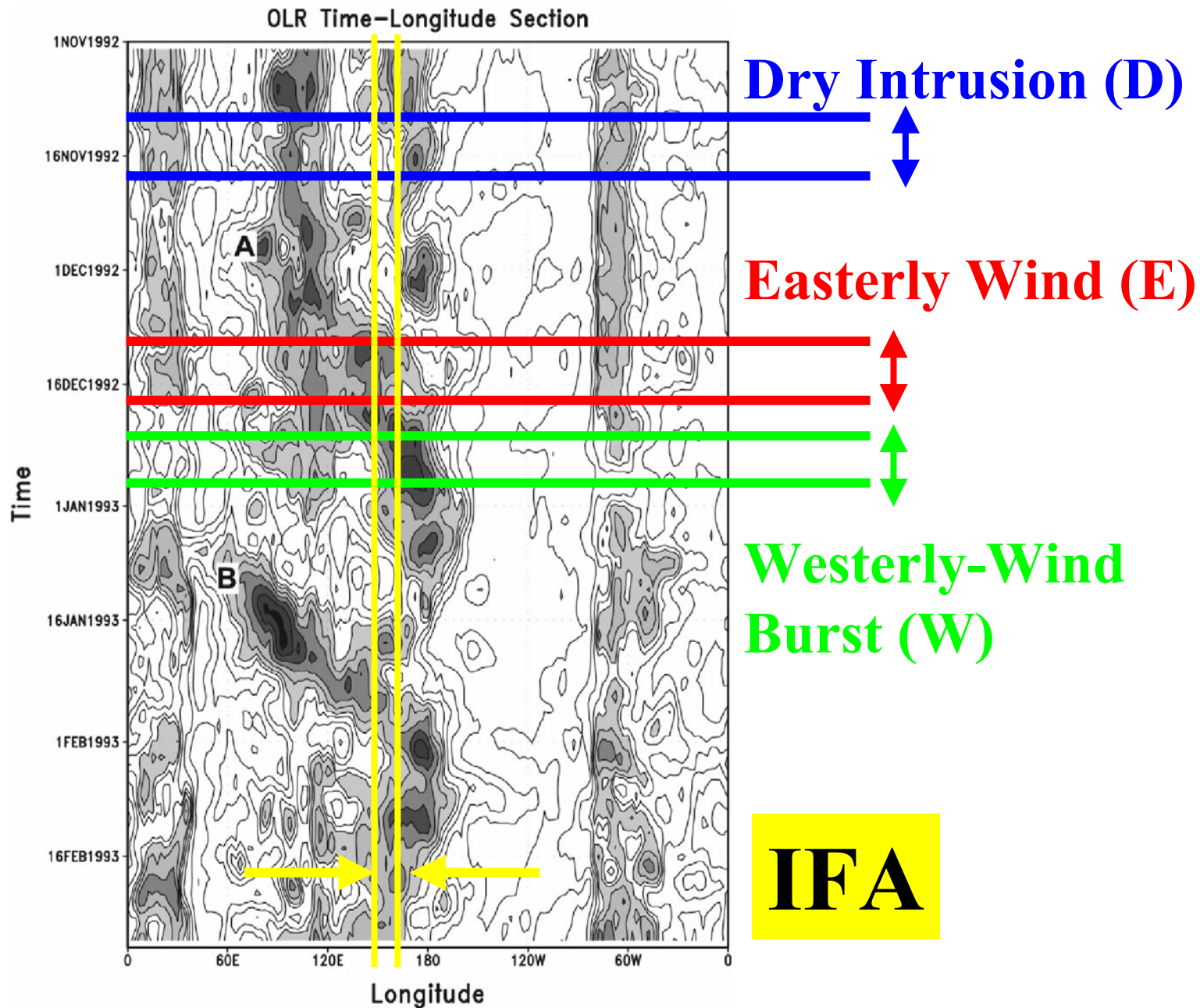
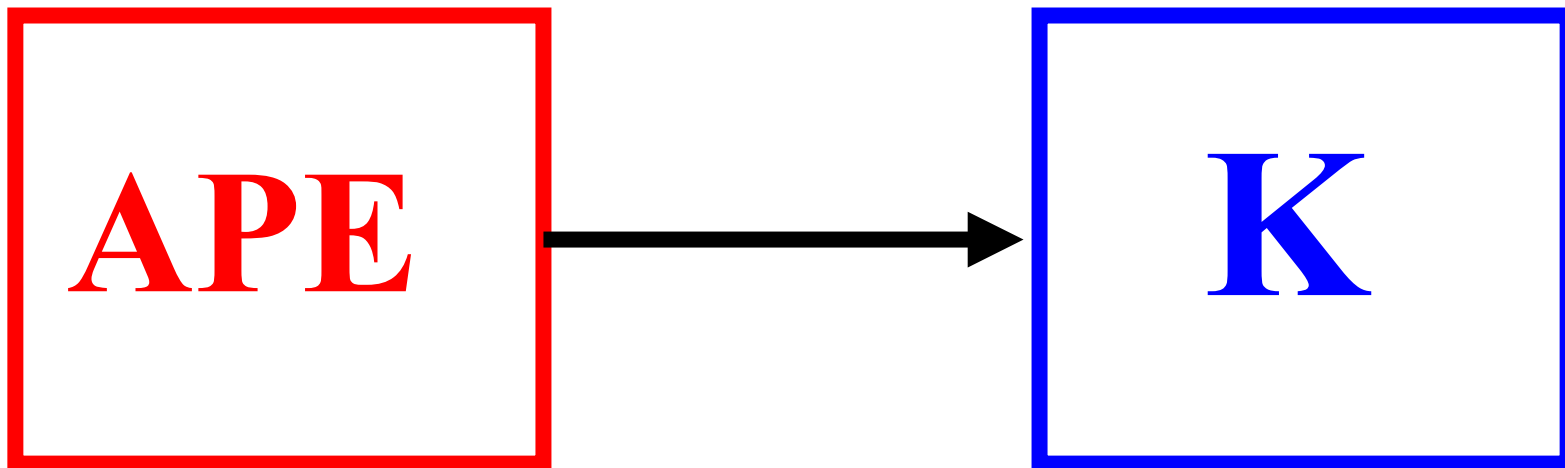
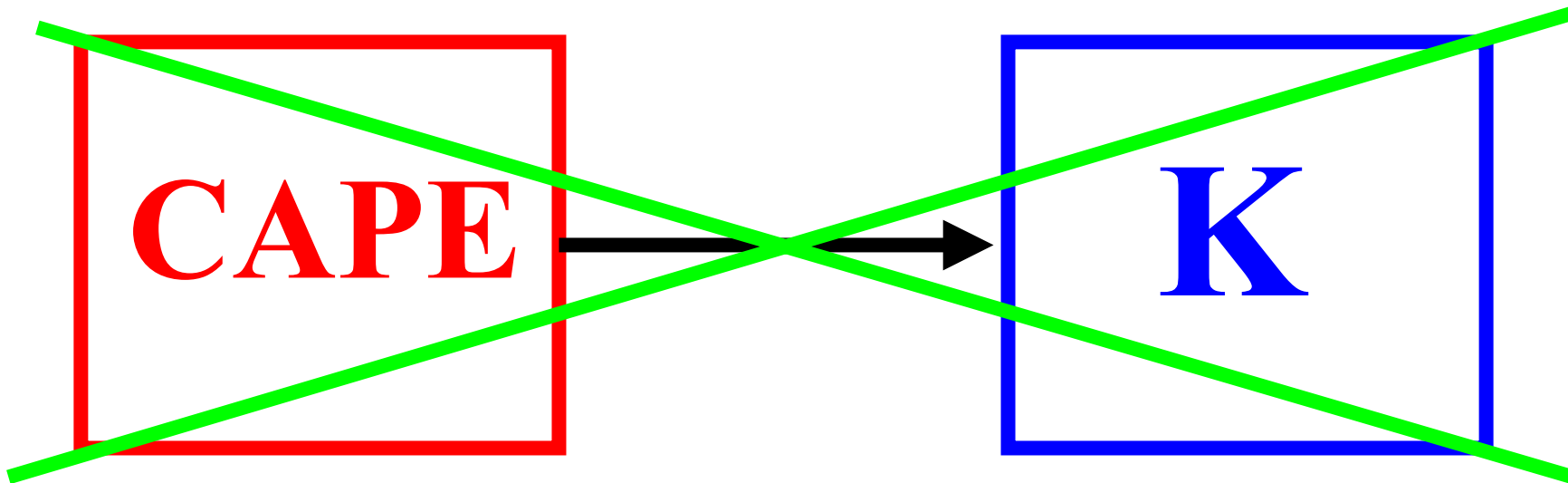

FIG. 3. Longitude-time section of OLR ($W m^{-2}$) averaged between $5^{\circ}S$ and $5^{\circ}N$ (contour interval: $15 W m^{-2}$). Areas with

Energy Cycle of the Convective System



~CAPE

Energy Cycle of the Convective System

(cf., Eq. 132, Arakawa and Schubert 1974)

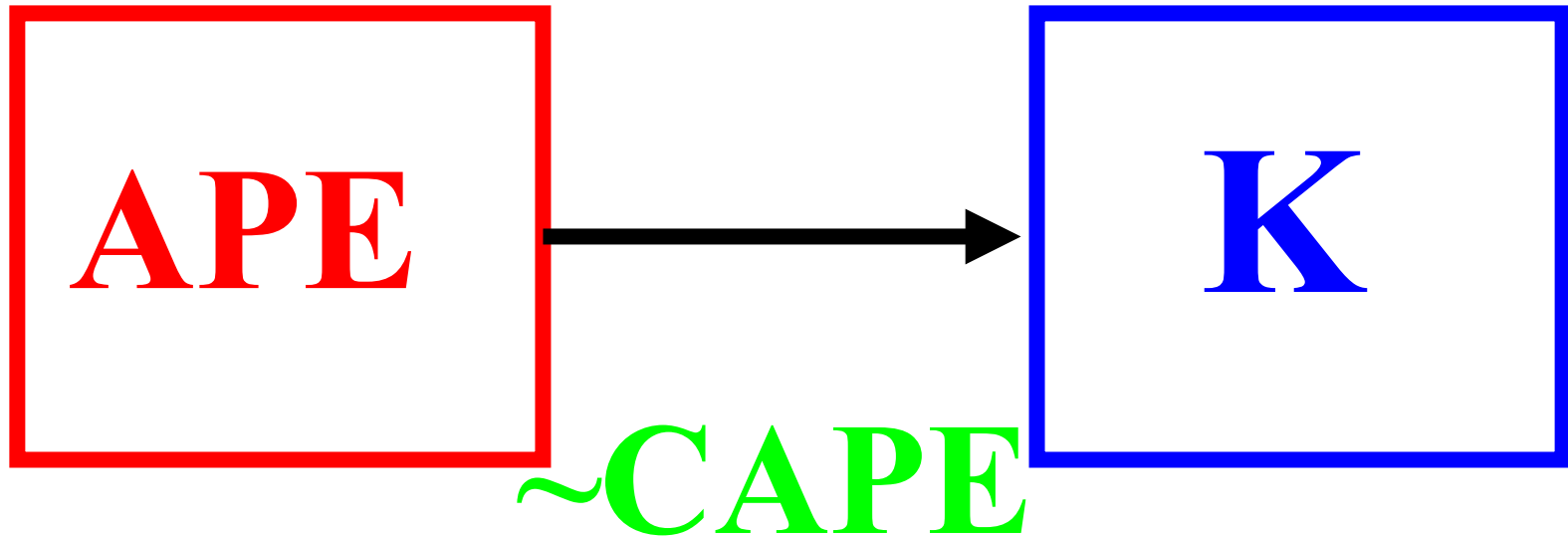

$= M_B \underline{A}$ (cloud work function:
entraining plumes)

$= (\rho w) * \underline{PEC}$ (CRM:
potential energy convertibility)

Three-Month Souding Data

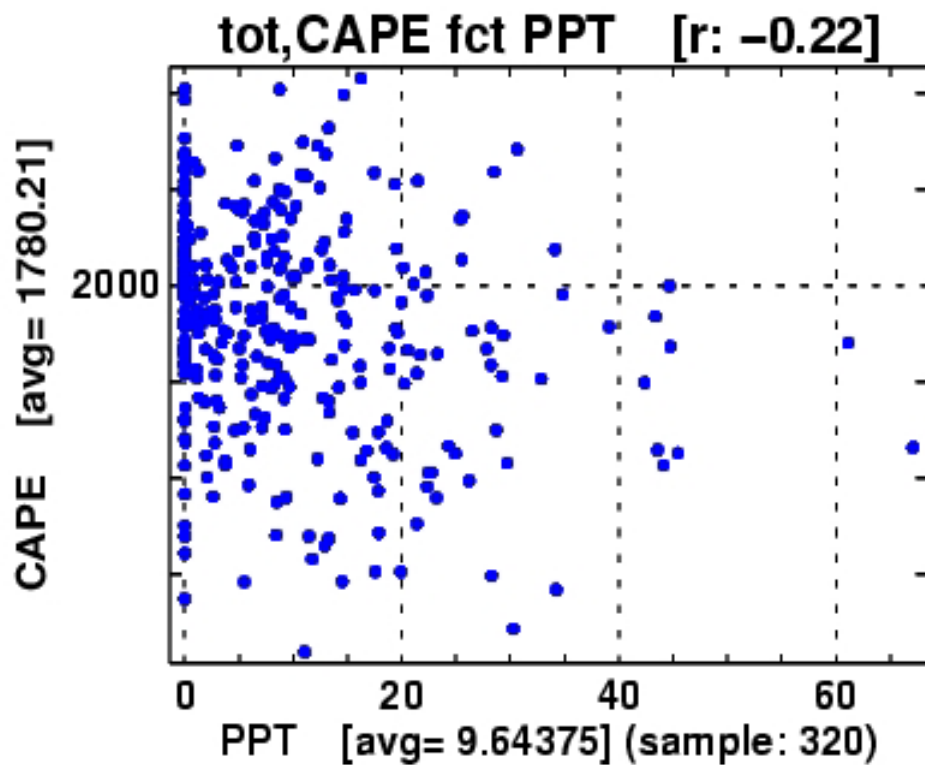

precipitation

(b)

PEC versus rainfall

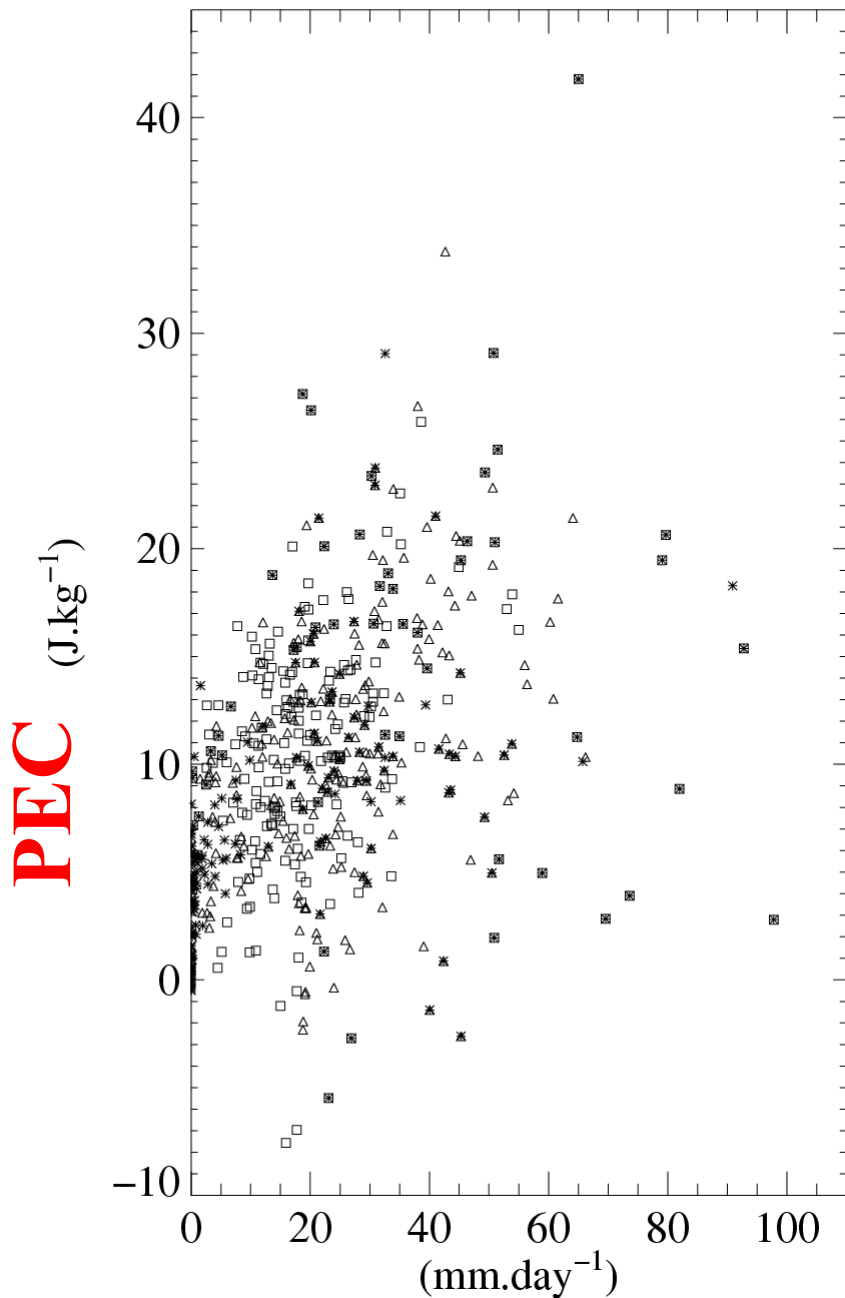

precipitation

Lifted parcel buoyancy

PEC-based buoyancy

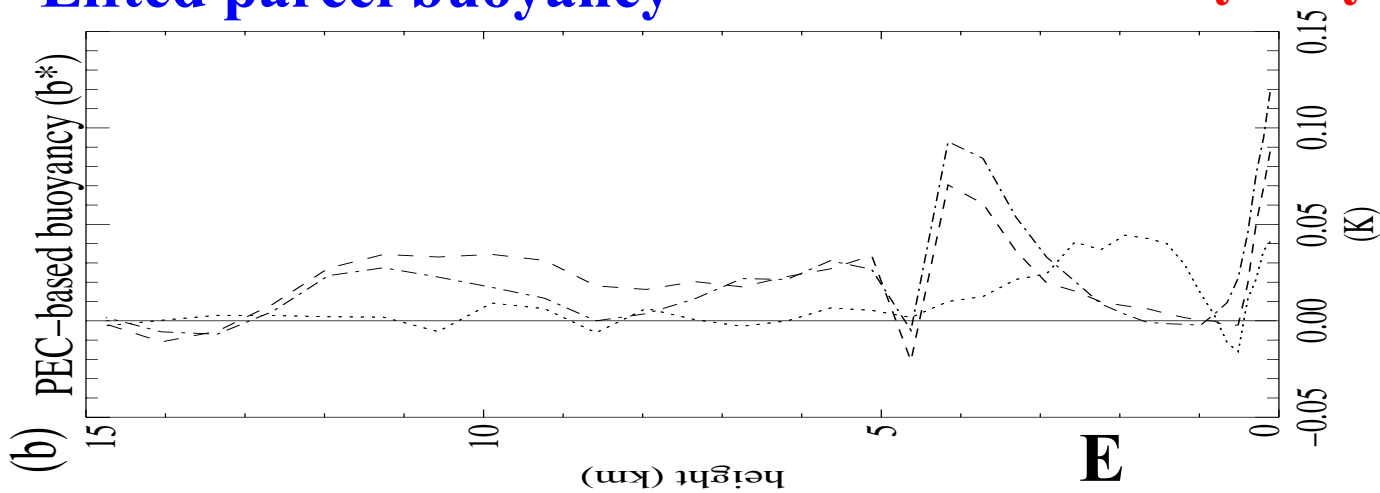
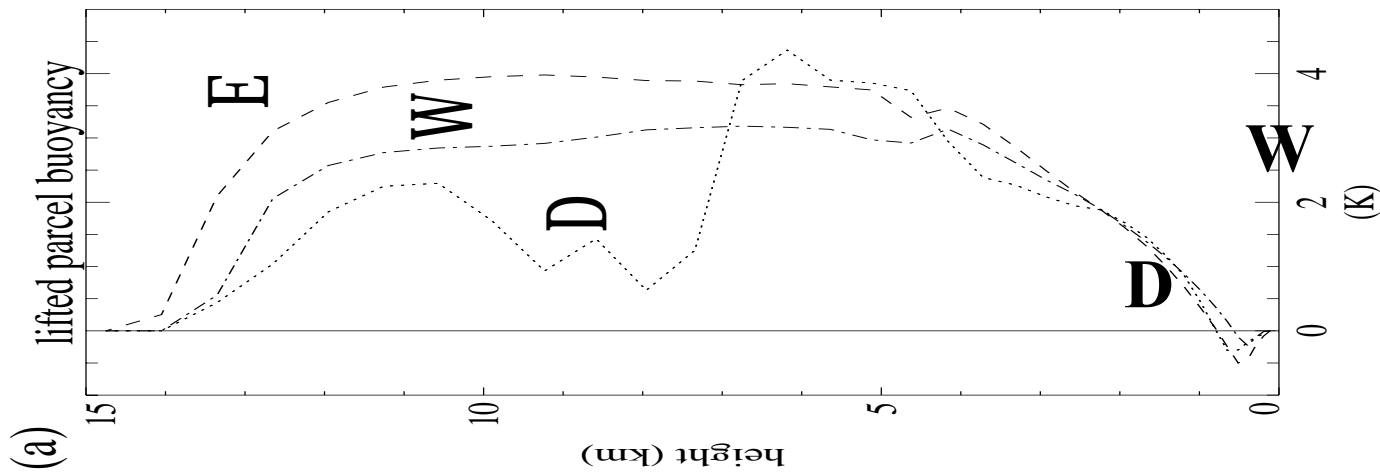

PEC-based buoyancy

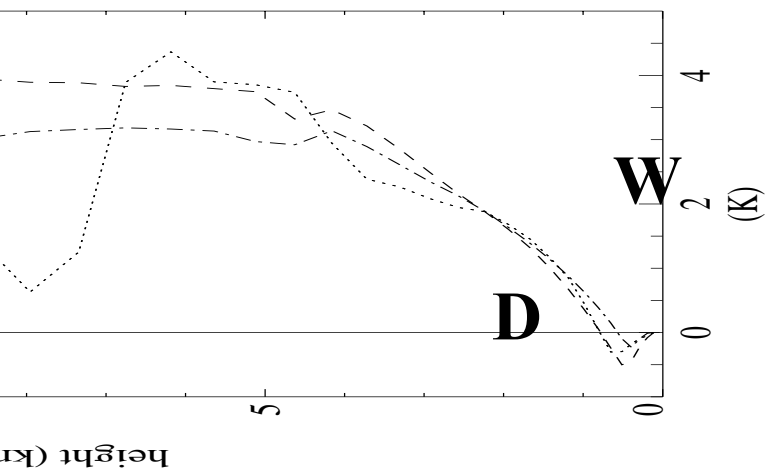
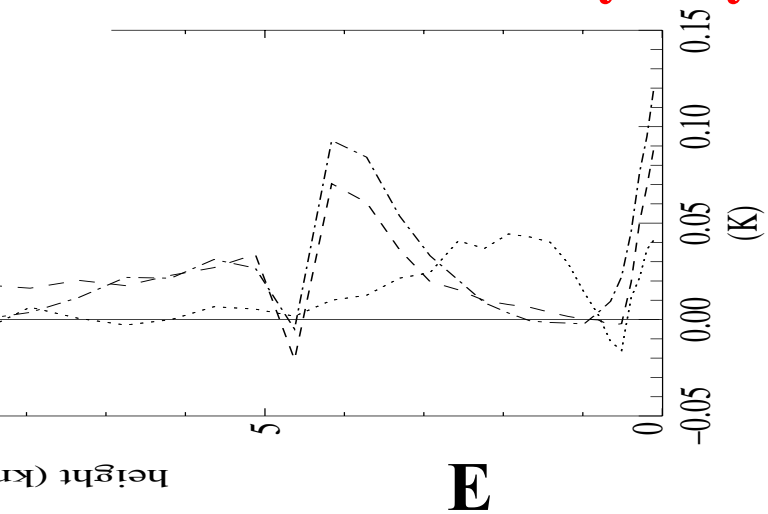

Entrainment Rate

Required to recover PEC-buoyancy

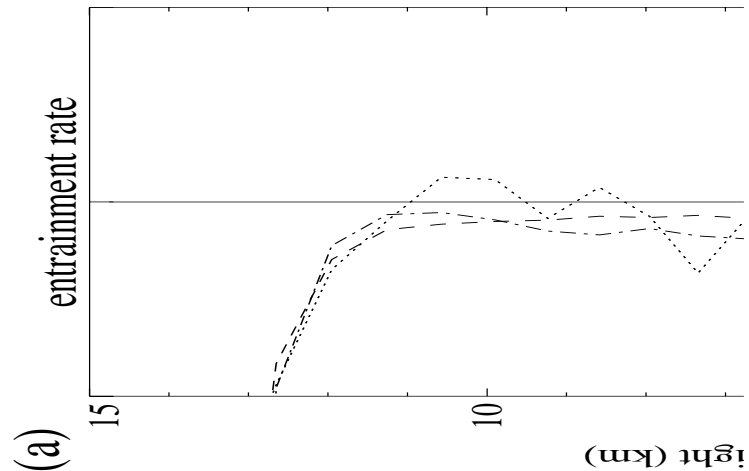
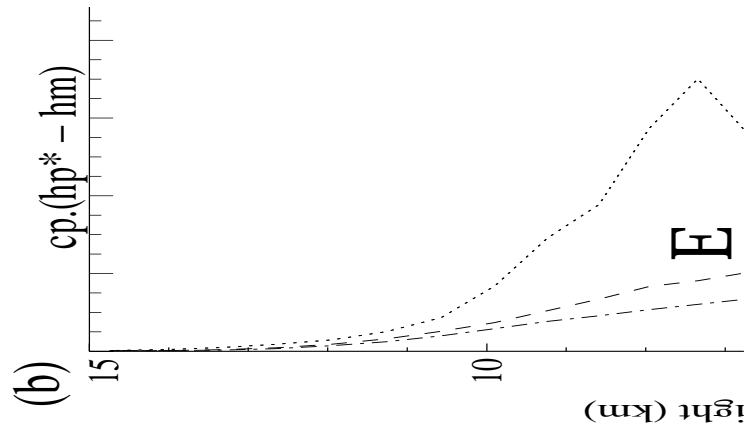

Entrainment Rate

Required to recover PEC-buoyancy

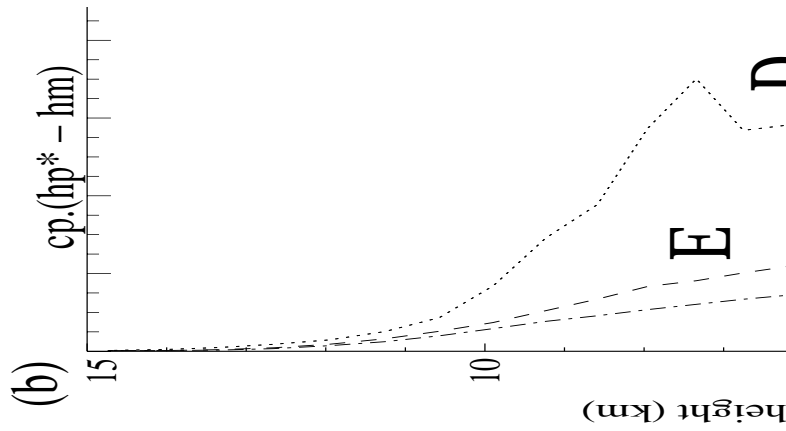

Moist Static Energy Deficit

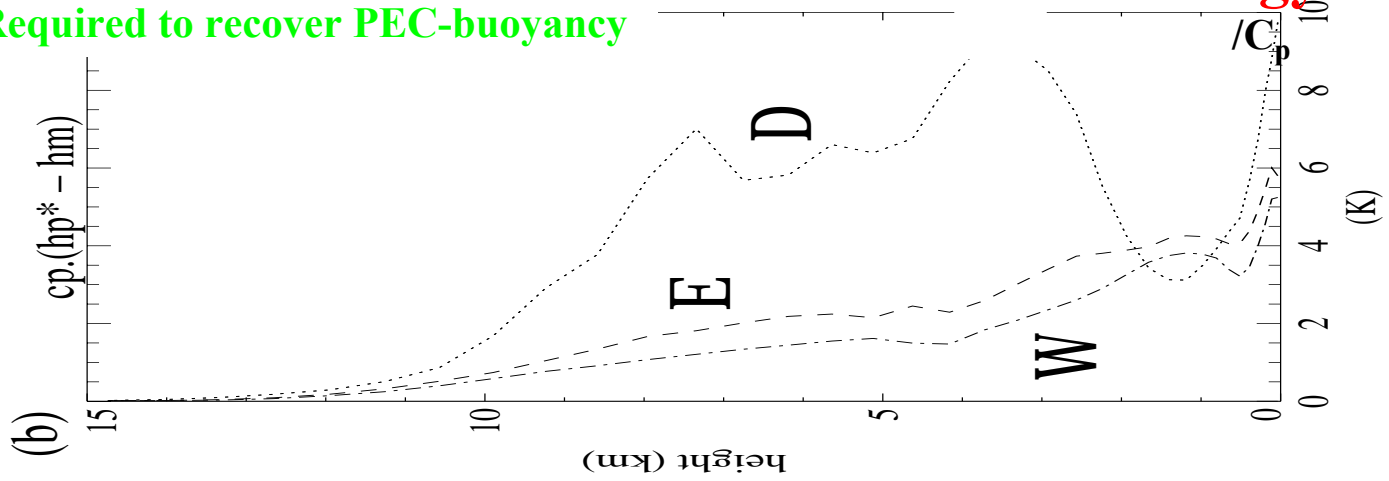

**Quantification of
Moisture-Convective Feedback**

Approaches for the Global-Model Convective Representation

Traditional Approach (Critics)

Scale-Separation → **Quasi-Equilibrium** →

(Yano 1999) (Yano, Grabowski, Roff, Mapes 2000; Yano 2003)

$$\tau_c \ll \tau_L$$

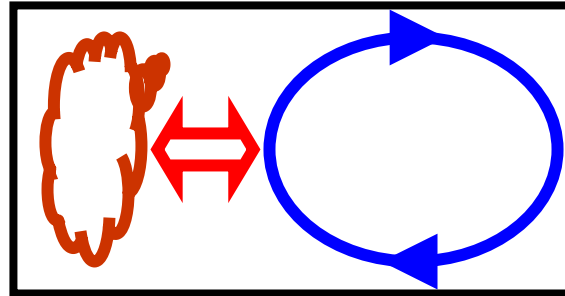

Mass Flux

(Yano, Guichard, Lafore, Redelsperger, Bechtold 2003; Yano, Guichard, Bechtold, Redelsperger 2003g)

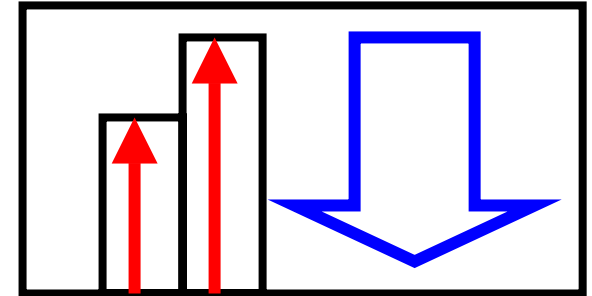

Proposed New Approach (references)

Scaling (Yano, Takeuchi 1987; Yano, Nishi 1989; Yano, Fraerich, Blender 2001) → **Self-Criticality** (Yano, Blender, Zhang, Fraedrich 2003) →

(fractal & 1/f-noise)

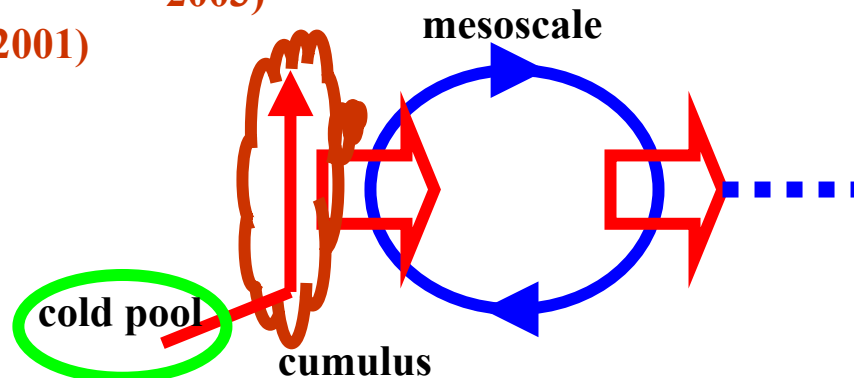

Wavelets

(Yano et al. 2001a, b, 2003e, f, g)

System =

cold pool mode
+
cumulus mode
+
mesoscale mode